

Special report on America's most advanced automobile



This is the story of  
**TORONADO**

the new one-of-a-kind car . . .  
 engineered by Oldsmobile!

1966 marks the debut of one of the most advanced automobiles ever to hit the American scene. Its name: Toronado. Built by Oldsmobile Division of General Motors Corporation. Years of development. Thousands of manhours of research, design, engineering. Over a million miles of testing, refining, retesting.

Toronado represents the epitome in Oldsmobile's line of Rocket Action Cars for 1966 . . . Ninety-Eight, Delta 88, Dynamic and Jetstar 88, Starfire and 4-4-2, F-85 and Vista-Cruiser.

But this is the story of Toronado—Oldsmobile's distinctive new one-of-a-kind car . . . its unique characteristics and its remarkable development.



This special section of advertising has been prepared by Oldsmobile Division, General Motors Corporation, to acquaint you fully with the new Oldsmobile Toronado—what it looks like, how it differs from other cars, how it came about and what it means to you.

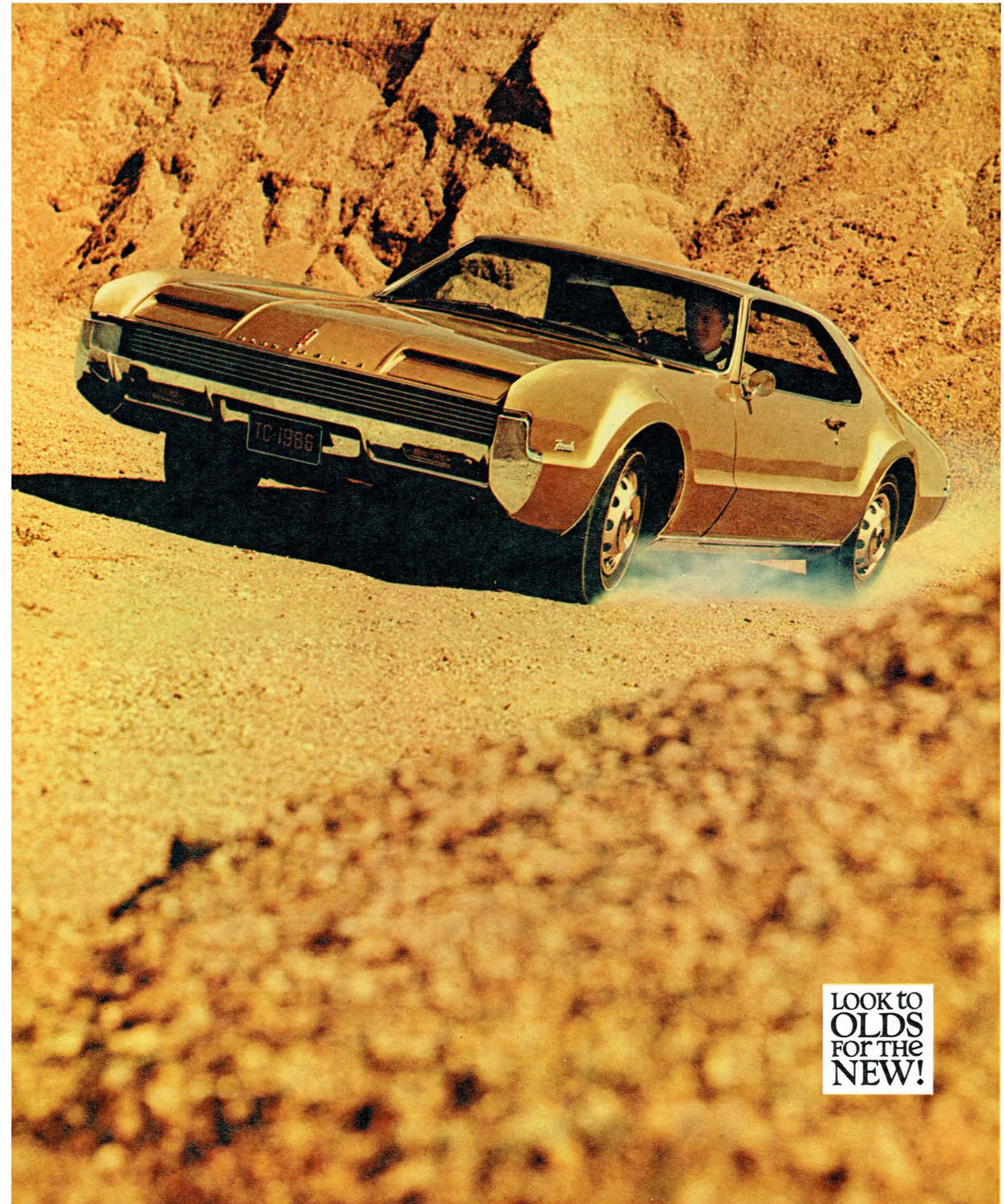

**LOOK TO  
 OLDS  
 FOR THE  
 NEW!**

Another automotive first from Oldsmobile!

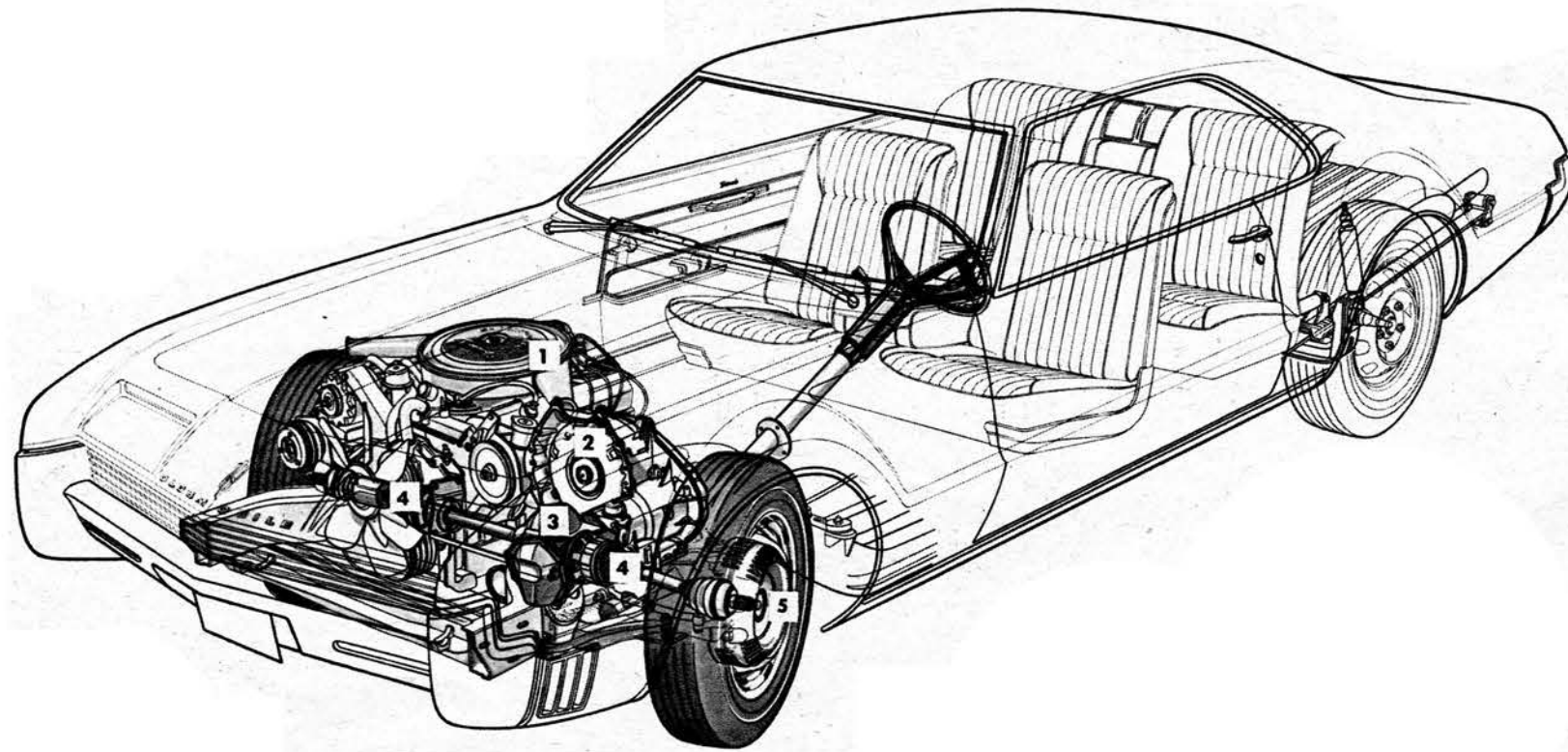

## TORONADO

Only full-size car with front wheel drive!

Toronado would have a lot going for it even if looks and luxury were its only credentials. But not so. Toronado began with a total engineering idea—front wheel drive. And it went on from there.

Simply stated, front wheel drive is a system that feeds engine power to the front wheels—rather than the rear wheels, as in conventional automobiles. And in Toronado's case, the benefits of the f.w.d. system stretch for a country mile!

Toronado cornering is unique since front wheels pull you around curves (rather than push). Flat. Stable. With a solid, commanding sense of control because the "pulling" wheels are also the "steering" wheels.

Toronado increases traction on straight-aways, too... improves stability in gusty crosswinds! That's because all major components (engine, transmission, differential... and steering) are positioned up front, where the traction is!

Tunnel's gone, of course. Without the conventional drive line to rear wheels, Toronado's floor is flat, front and rear!

Trunk's deeper. With no gears in the rear, utility of luggage compartment is improved.

### HERE'S TORONADO FRONT WHEEL DRIVE IN DETAIL:

1. Power is supplied by a 385-hp Toronado Rocket V-8 with new Quadrajel Carburetor that delivers cruising economy, top performance.
2. Turbo Hydra-Matic is a completely new design featuring variable-vane torque converter.
3. Low-friction planetary differential is exclusive Olds design, transfers power through 3.21-to-1 gear ratio.
4. Power is transferred to front drive shafts, each with twin constant-velocity universal joints.
5. Large front wheels with 8.85 x 15 tires provide superior traction under varying road conditions.

And Toronado's quieter. No drive line through the passenger compartment. And with major mechanical components up front, drive noise and vibration are isolated.

Great, you say? Great, indeed! But it takes Oldsmobile's brand of engineering to harness the advantages of front wheel drive. And then add all-out performance. And distinctive style. And six-passenger comfort besides.

See how Toronado tracks in action (opposite page). Then turn overleaf to see where that action comes from!

Toronado's up-front tracking lets you take to the road with ease  
... improves stability on curves ... provides excellent handling!

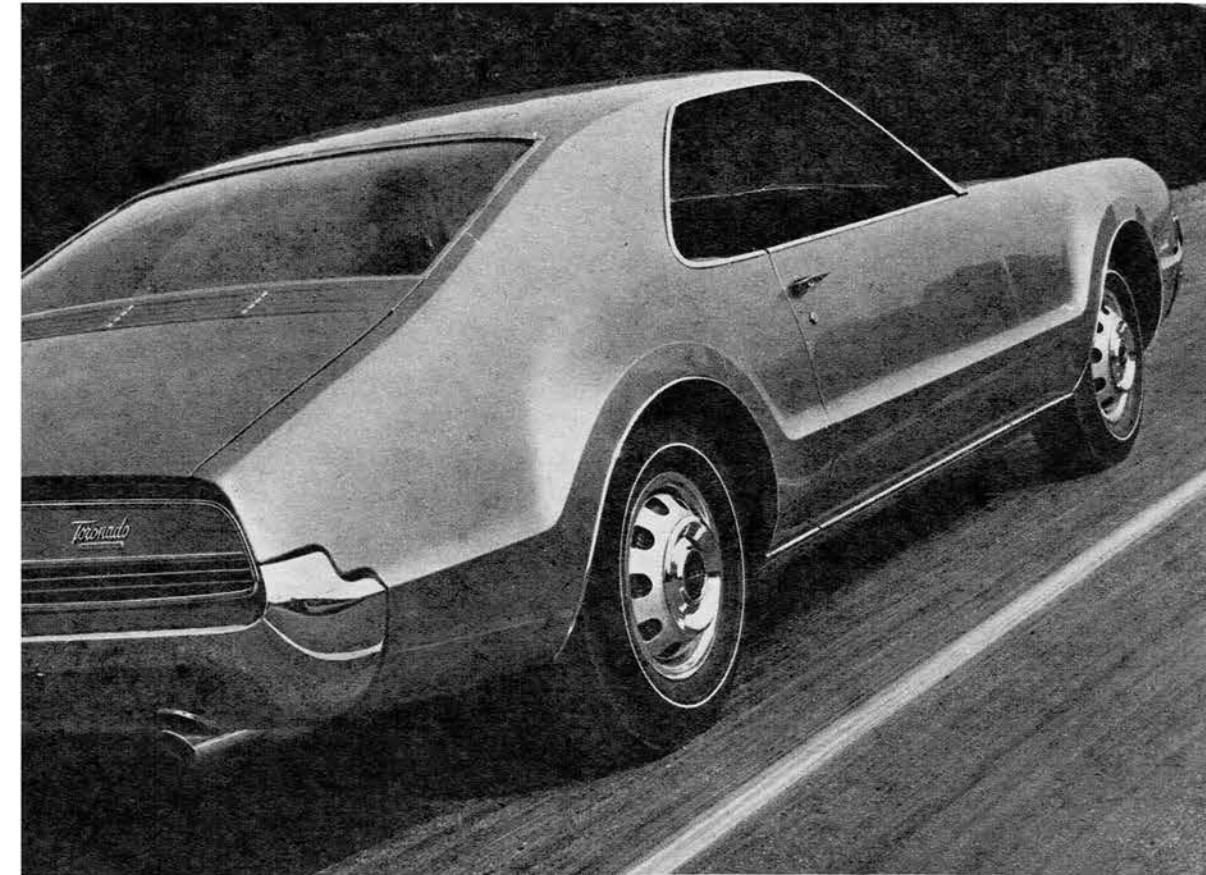

You aim it, Toronado obeys! With power up front, you stay right on course—even in gusty crosswinds! Unique weight distribution, plus torsion bar suspension, contribute to Toronado's roadability and ride, too.



Goes in snow! Toronado's unique up-front traction pulls rather than pushes... makes for steady going on snowy roads.

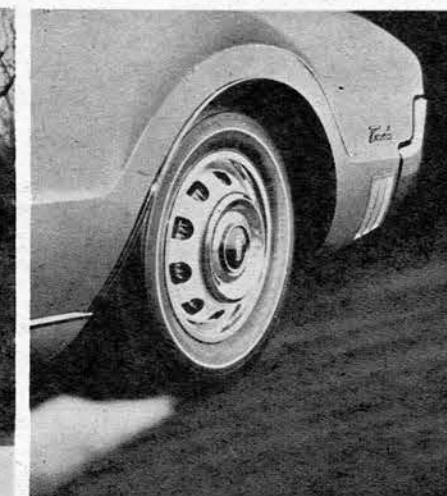

Burly and businesslike! 8.85 x 15 tires, standard, give Toronado a real grip. Wheel cutouts help cool brakes.

**LOOK TO  
 OLDS  
 FOR THE  
 NEW!**



Beautiful way to thread a needle! Torsion-bar front suspension, leaf rear spring, six shock absorbers reduce lean on turns!

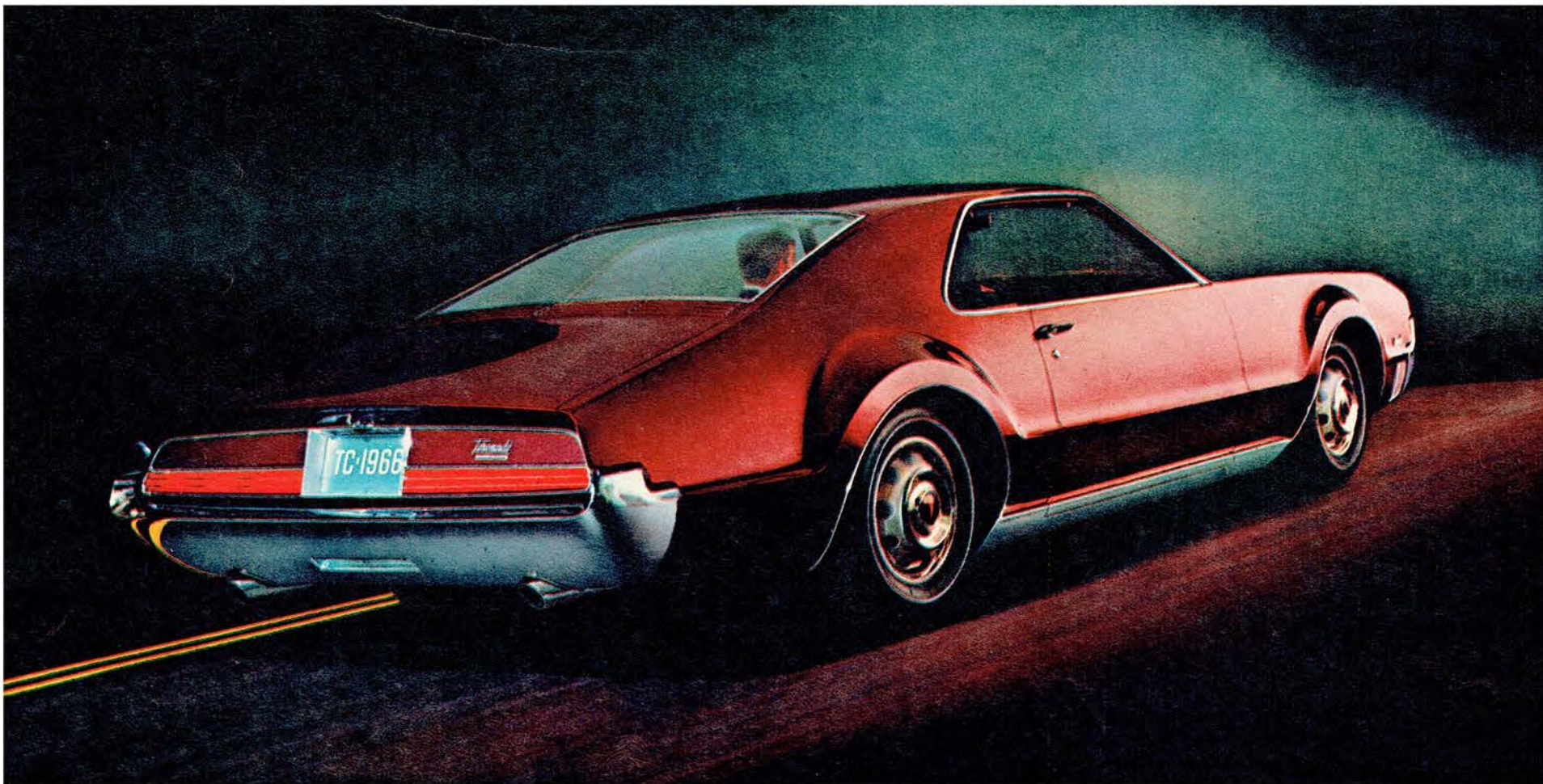

## Ho-hum driving is out ... Toronado's in!

A full-size car needs full-size performance. And Olds isn't one to spare the horses. Planted under Toronado's long, low-slung hood is a new Toronado Rocket V-8, specially engineered for a special brand of action!

Specifically, Oldsmobile's Toronado Rocket turns out 385 horsepower. Delivers 475 lb.-ft. of torque at 3200 rpm. Provides a 425-cubic-inch displacement and an ultra-high 10.5-to-1 compression ratio.

A newly developed Quadrajete Carburetor offers a 40% increase in air capacity. Provides better fuel-air mixture. Prevents low-speed stall-outs. Boosts economy.

Now add Toronado's own version of Turbo Hydra-Matic. A unique drive system and a direct coupling to differential smooth out the Rocket action. And Turbo Hydra-Matic (standard, mind you) is ahead of the passenger compartment, providing a flat floor.

Action, you ask? Action you get! But the real proof of Toronado's beautiful behavior shows when you take the wheel and take to the road. Won't you be our guest?

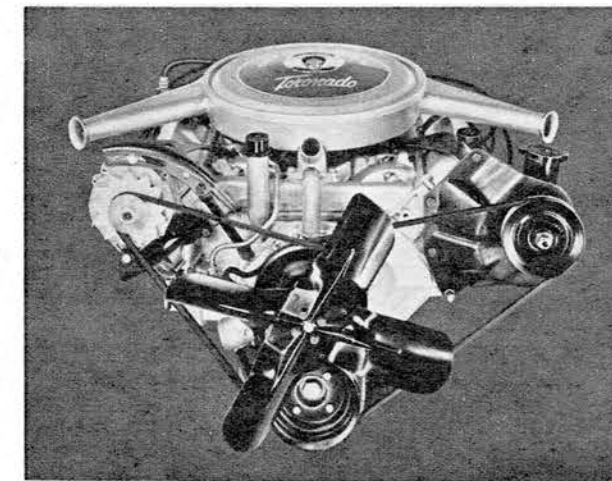

Twin-snorkel air cleaner atop Toronado Rocket V-8 boosts air flow, improves carburetion, assures quieter operation.

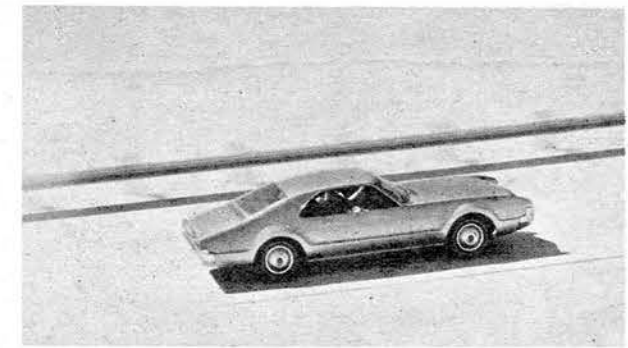

Toronado's deep-throated dual exhausts are handsome and functional too. Chrome collars add a sporty touch. Critical parts of resonated exhaust system are aluminized against corrosion.

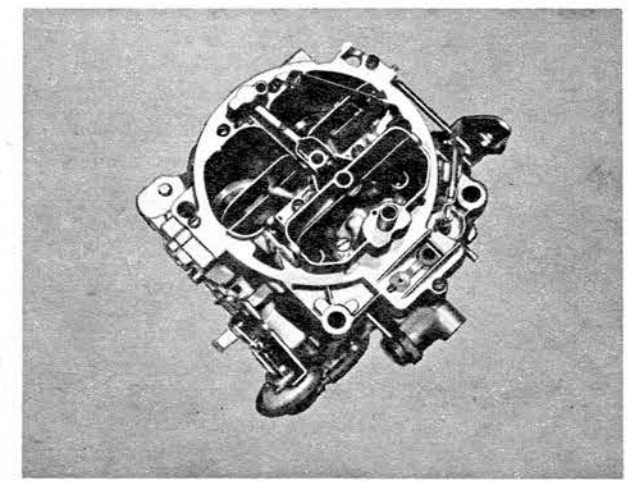
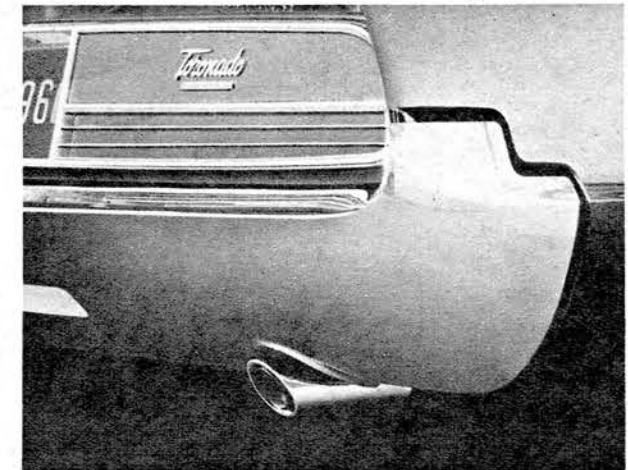

New Quadrajete Carburetor—specially designed for Toronado—feeds engine with smooth economy at all speeds.

LOOK TO  
OLDS  
FOR THE  
NEW!

# TORONADO

The only thing it shares with any other car is the road!



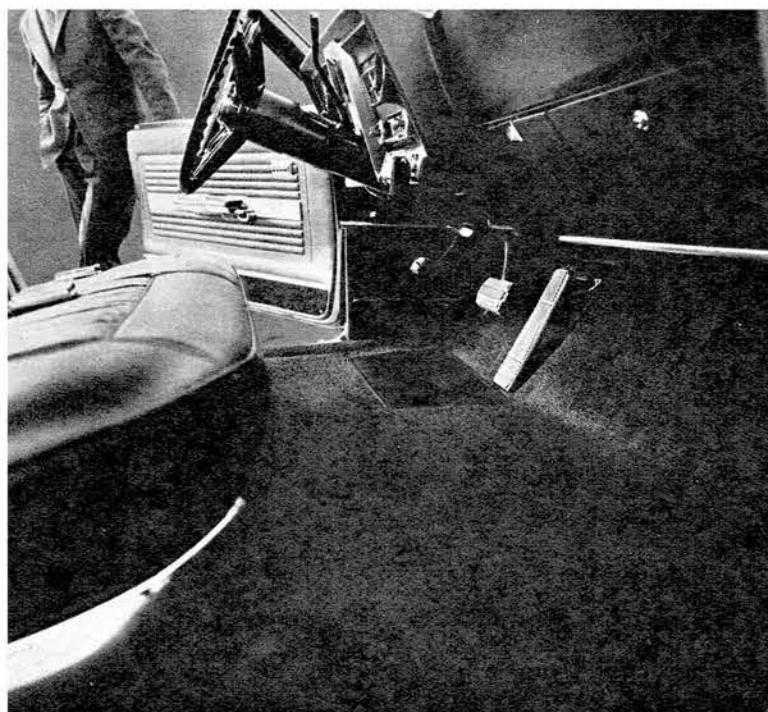

## Toronado gives a brand-new look to the lap of luxury!

Easy entry . . . flat floors . . . room for legs as well as luggage. That's how Toronado's tailored!

Don't just stand there dreaming. Step up and step in! You'll discover that only a car that's engineered new—from the road up—could do what Toronado has done with inner space.

Take getting in, for instance. Toronado's door is 3.5 inches wider than conventional full-size coupe doors. Swings wide to let you in. And opens far behind seat back for easy access to either front or rear seat.

Toronado's as easy to sit in as it is to get in! Did you ever see a flatter floor? Center-of-seat passengers finally get a break. (Toronado takes six, you know!)

Luggage? In a fastback? Plenty in Toronado! With no rear axle hump (courtesy of front wheel drive) Oldsmobile's one-of-a-kind car has a one-of-a-kind trunk, too. Deep. Spacious. Flat-floored. All usable!

Make no mistake: Toronado is a full-size car for full-size people. For the record, wheelbase is a generous 119 inches. Overall length, an impressive 211 inches. Width is nearly 79. Plenty of space to give you the six-passenger roominess of a sedan . . . in the cool style of a coupe!



Toronado's as airy as it looks. Full-view side windows form a functional part of unique new draft-free ventilation system. Outside air enters front of car at two levels, through five adjustable vents. Circulates throughout passenger compartment. Flows out, under pressure, beneath the rear window. Result: A steady flow of air without noise or draft.

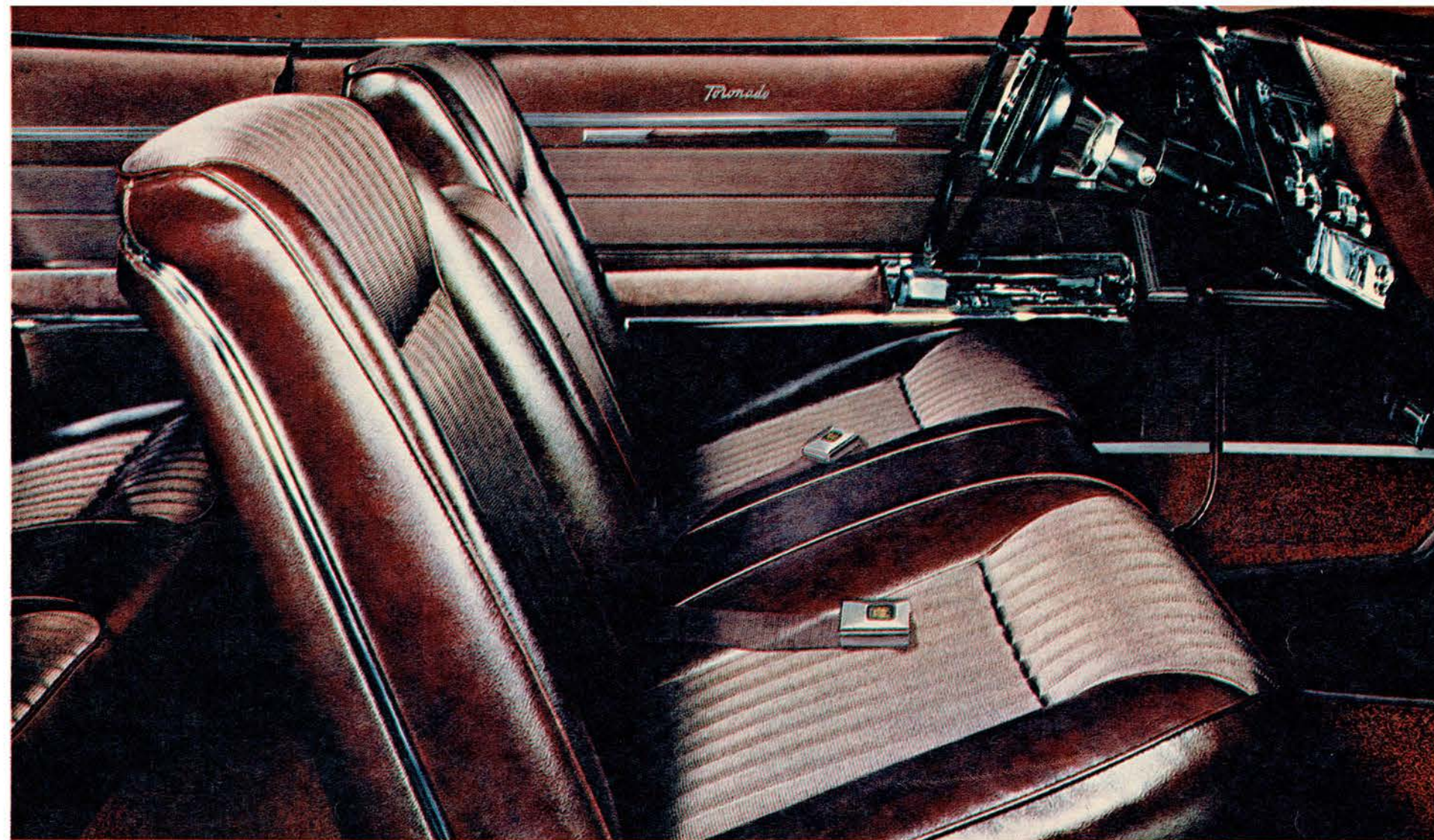
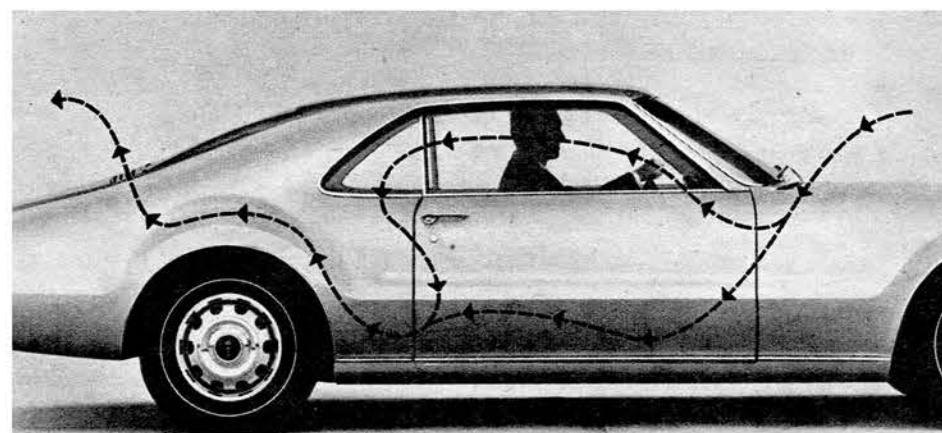

Toronado interior begs you to buckle up and begone! Versatile Strato Seat (standard on Toronado Deluxe) features fold-down center armrest, converts to twin bucket-type cockpits. Seat belts, front and rear, are standard.

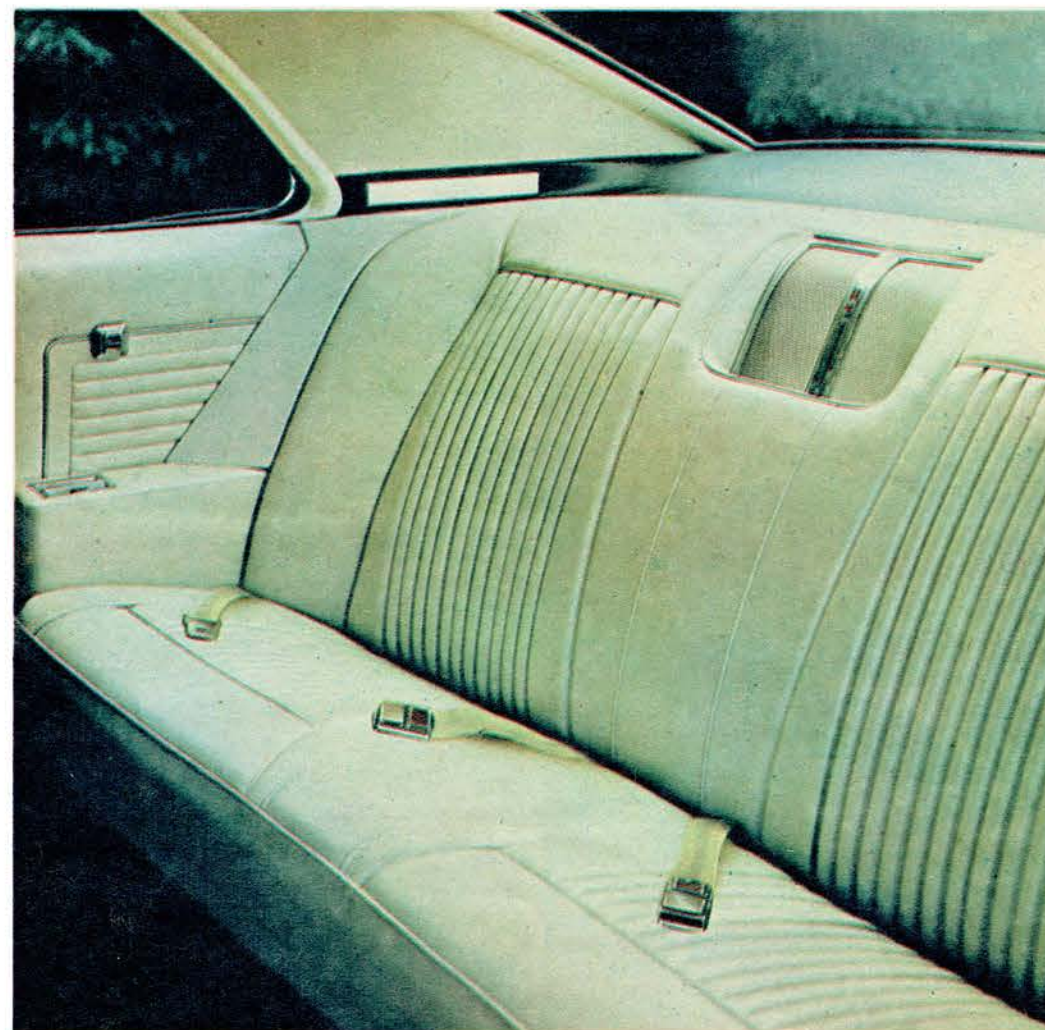

Three's no crowd in Toronado's rear seat! Wide. Soft. Cove-contoured at both ends. Toronado's rear "sofa" makes back-seat driving almost as much fun as taking the wheel! Seven interior colors.

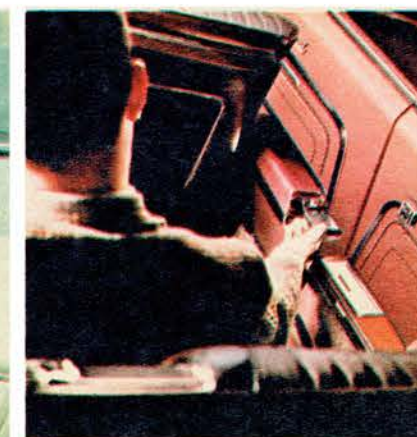

Easy way out for back seat passengers! Dual door handles, standard on Toronado Deluxe, enable both front and rear passengers to open doors. Door opening extends beyond front seat to make rear seat entry and exit still easier.

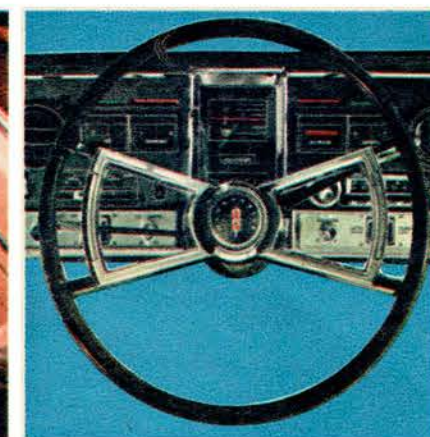

You could almost bring it in on instruments! Conveniently positioned dials, unique drum-type speedometer, twin ashtrays with lighter, padded dash and padded sun visors are all part of Toronado's smart new instrumentation.



Front-seat passenger can tilt back 30° when you order adjustable reclining seat.



Concealed headlamps swing open automatically when lights are turned on.

## Years ago an idea was born . . .

Many years ago, a group of hand-picked Oldsmobile engineers undertook an important multiple challenge: Develop an automobile that would unlock the limits on passenger space; surpass all conventional standards of ride, handling, performance; and offer up a new concept of style.

**Solution:** A front-wheel-drive car that presented advantages even beyond the original objectives. For the benefits of front wheel drive are many:

More passenger space and flat floors by eliminating drive shaft.

Improved utility of luggage compartment because there are no gears in the rear.

Elimination of long rotating drive shaft to reduce noise and vibration.

Improved traction and increased directional stability, since the "pulling" wheels are the "steering" wheels.

Completely fresh look . . . a style no longer dictated by conventional mechanical requirements.

Olds technicians understood the challenge. They had pioneered new engineering frontiers before. Now, recognizing the advantages of front wheel drive, they set to work.

## and over a million miles later, the Toronado is reality.

First designs were committed to blueprint. Checked. Built. Tested. Revised. Tested again. Oldsmobile's vast experience with electronic computers was channeled to the problem. Hundreds of component designs were mathematically analyzed. Slowly, but very surely, Toronado began to emerge.

In the laboratories, parts were cycled millions of times. Test cars were built. And finally, the vast General Motors Proving Ground facilities and personnel went into round-the-clock action.

Tests were conducted in every kind of weather. Over every kind of terrain. For over a million miles, the sleek new pilot models were put to the toughest torture tests ever devised for a car.

**Result:** Toronado, America's most advanced automobile!

**LOOK TO  
OLDS  
FOR THE  
NEW!**

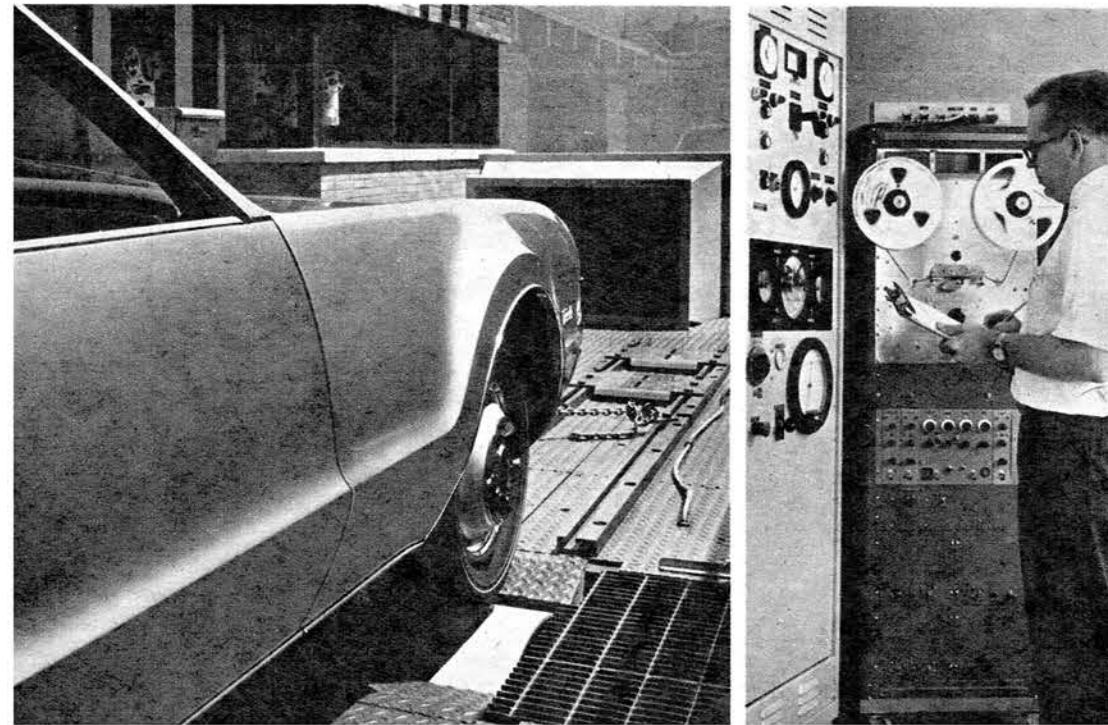

Trouble is tuned in . . . engineered out. Electronic computer (right) plays tapes of actual road tests. Chassis dynamometer and Toronado pilot model riding on it (left) react accordingly. Toronado went through up to 1,000 miles a day of this taped torture at Oldsmobile's modern Engineering Center!



Even a fifth wheel has its function! This one is calibrated to fractions of a mile-per-hour. Records every move the Toronado made in miles and miles of grueling performance around the Proving Ground track. Supplies data for evaluating the test car's response under varying performance conditions.

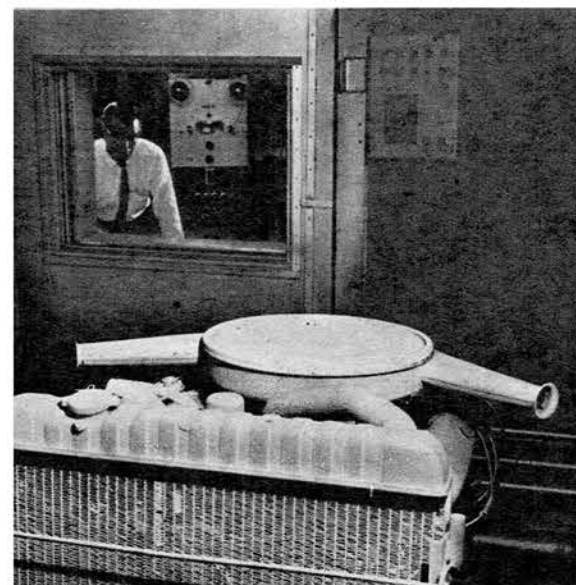

Ninety below! Toronado Rocket V-8 was started, stopped, started over and over in Oldsmobile's Cold Room at temperatures as low as ninety below!



Delicate dipstick! Test data is recorded by sensitive instruments that measure fuel consumption to the tenth of an ounce!

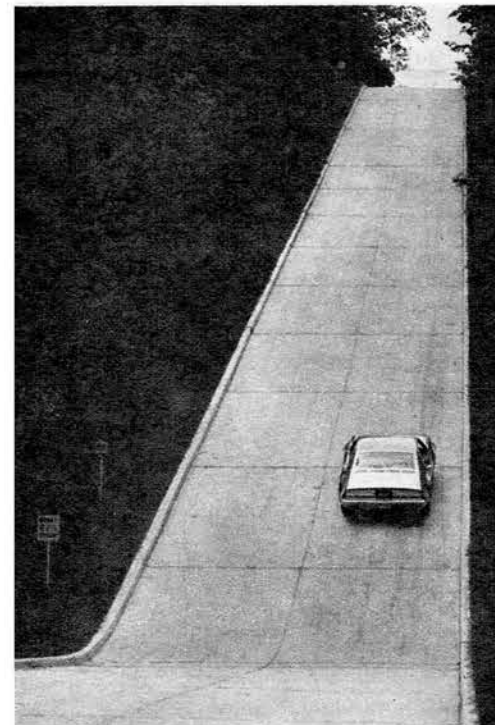

Toronado climbs a mountain in its own backyard! Grades up to 60%—far steeper than any road—test Toronado's climbability!



Thorough dunking! Toronado passes water trough test with flying colors! Electrical system gets the acid test. Salt water checks out corrosion resistance of critical components.

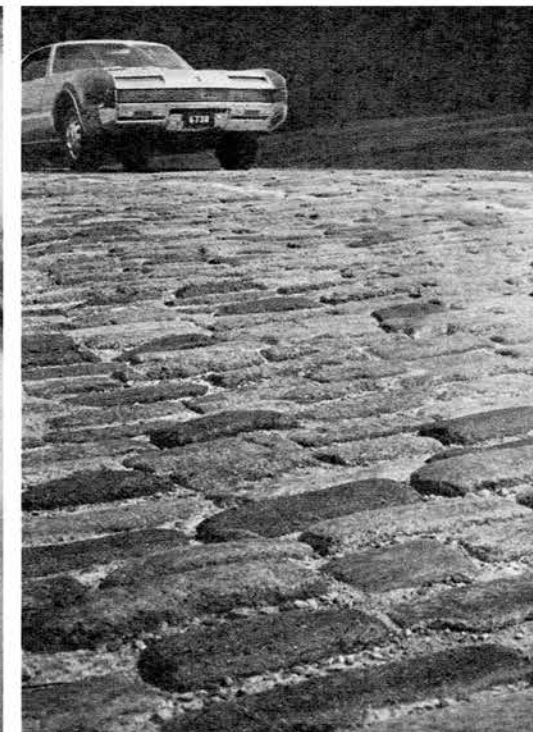

Toronado—on the rocks! "Belgian Block", replica of rocky trek from Amsterdam to Brussels, torture-tested Toronado for thousands of miles.



Round and round she goes! Mile after mile on the high speed oval measures Toronado's durability. Stops are made only for fuel and routine maintenance.



Hot and fast for a hundred hours! In the searing heat of the Arizona desert floor, Toronado is run at varying speeds . . . for 100 hours . . . at 100° Fahrenheit. Durability under adverse conditions never got a better test and Toronado pilot models passed their exams summa cum laude!



Two-ton tow! Four-thousand-pound dynamometers are towed hour on hour, simulating various grades and driving conditions to produce accurate readings on the road power developed by the 385-hp Toronado Rocket V-8.

## Oldsmobile engineering leadership takes another bold step into the future!

To call Toronado the newest, most advanced car of 1966 is something of an understatement. For no other car looks like Toronado. No other car rides like it. No other car drives like it.

But then . . . Toronado is the kind of progressive automotive achievement America has come to expect from Oldsmobile. Latest in a long line of engineering "firsts" . . . each offering new evidence that you can always "Look to Olds for the New!"

Oldsmobile engineering—famous for firsts!

- First high-compression V-8 engine
- First completely automatic transmission
- First nickel and chrome plating
- First automatic headlight dimmer
- First four-door hardtop sedan
- First high-compression turbo-charged engine

Toronado highlights a smartly styled line-up of out-front Oldsmobiles for 1966 . . . presenting a total spectrum of selection. No matter what type of car you favor, Oldsmobile's Rocket Action models offer a full range of choice in size, body styles, power plants, appointments and price! And every one is moving proof that you can . . .

Look to Olds for the New!



Ninety-Eight Luxury Sedan



Delta 88 Holiday Coupe



Dynamic 88 Holiday Sedan



Jetstar 88 Holiday Sedan



Cutlass Supreme



F-85 Deluxe 4-Door Sedan



Starfire Coupe



4-4-2 Cutlass Holiday Coupe



3-Seat Custom Vista-Cruiser

*STEP  
OUT FRONT  
IN '66...*

*in a Rocket Action Olds!*

## There's a Rocket for every pocket!

Some people make big luxury cars. Some make smaller economy models. Oldsmobile makes both—and everything in between!

Take the fine-car class, for example. Here Olds offers a full range of top-of-the-line Ninety-Eight models. From the elegant new Luxury Sedan to the attractively priced Town Sedan. Plus a convertible and two smart hardtops to match anything you'll find in the luxury field!

Rocket performance and Oldsmobile style are yours in three stylish 88 series. Four luxurious Delta 88s. Four high-spirited Dynamic 88s. Three Jetstar 88s, priced low—right down with cars in the popular-price field! Eleven 88s in all—one just right for you!

Look what Olds offers in the low-price field! Five new budget-priced F-85s. Five great Cutlass models—highlighted by the glamorous new Cutlass Supreme hard-top sedan. Savings . . . luxury . . . Olds runs the full gamut in the low-price category.

Oldsmobile's spectrum of selection shows in the specialized fields. The giant-sized Vista-Cruiser and the value-packed F-85 Station Wagons meet every requirement of wagon lovers. And the stunning new Starfire and 4-4-2 do the same in the sports car field.

## And a full range of availabilities in car features, too!

Full range of sizes! Olds offers cars in five different wheelbases—from the trim 115-inch-wheelbase F-85 to the generous 126-inch-wheelbase Ninety-Eight. With five different car lengths to match!

Full range of performance! 385-hp Toronado Rocket V-8 to a brand-new, money-saving Action-Line 6 . . . Olds offers your kind of go for your kind of driving! Twelve great Olds engines in all. And four different transmissions to tailor them to your requirements.

Full range of appointments! Oldsmobile interior detailing, fabrics, convenience features and accessory items let you virtually tailor the Olds of your choice into a custom automobile!

Full range of prices! Low-price class . . . medium-price class . . . fine-car class . . . and all points in between! Forty spanking new, spirited new Oldsmobile models make the point: Now, more than ever . . . there's a Rocket for every pocket!

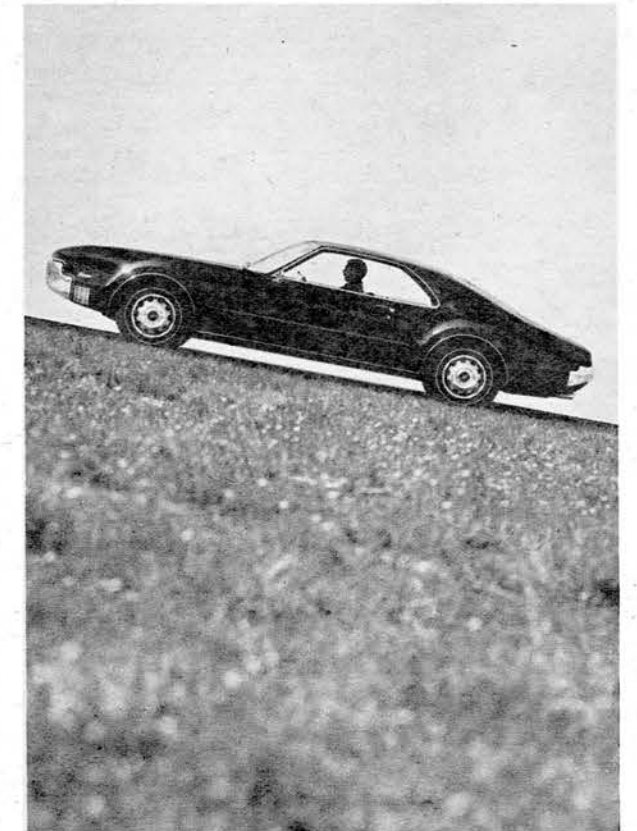

For '66, all Oldsmobiles feature the following standard equipment: front and rear seat belts, two-speed, non-glare windshield wipers, windshield washers, outside mirror, back-up lights, padded sun visors and padded instrument panel.

**LOOK TO  
OLDS  
FOR THE  
NEW!**

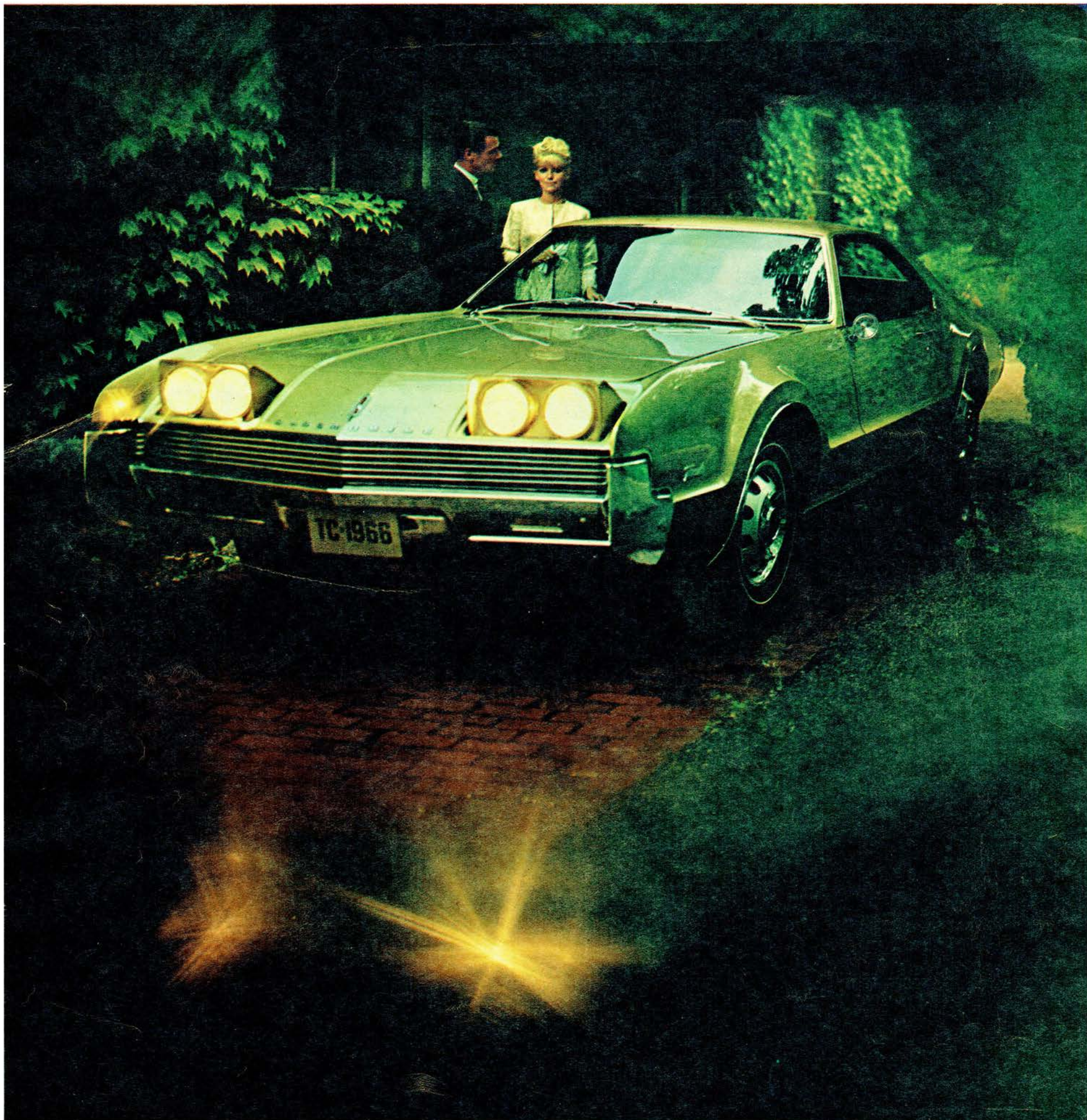

You're invited...to drive the newest, most exciting automobile in the world...at your Oldsmobile Dealer's