

GMC

TRUCKS

**LIGHT
TONNAGE
MODELS**



GMC

TRUCKS

LIGHT TONNAGE MODELS



The all-new line of GMC light-tonnage trucks...

For your greater convenience and safety, the following items are standard equipment on GMC's 1967 Light-Tonnage models (except cowl models): Instrument panel—padded edge, glare-reducing paint on crown, textured instrument background, flat knobs, safety-pull ashtray and safety latch glove box door; front seat shoulder belt anchors; padded sun visor; four-way hazard warning flasher; dual master cylinder brake system; windshield washer; dual speed windshield wipers with glare-reducing arms and blades; thick laminate windshield; left and right outside mirrors, except Pickup models—left outside and shatter-resistant breakaway inside day-night mirror on Pickup models; backup lights on Pickup and Stake models; seat belts; energy-absorbing steering column; passenger-guard door locks; front seat back lock; corrosion-resistant brake lines; soft, low profile window control knobs; and safety door latches and hinges.

Vehicles shown illustrate standard or optional factory installed equipment. Items referred to as options, optional or available are at extra cost.

The all-new line of GMC light-tonnage trucks...

For your greater convenience and safety, the following items are standard equipment on GMC's 1967 Light-Tonnage models (except cowl models): Instrument panel—padded edge, glare-reducing paint on crown, textured instrument background, flat knobs, safety-pull ashtray and safety latch glove box door; front seat shoulder belt anchors; padded sun visor; four-way hazard warning flasher; dual master cylinder brake system; windshield washer; dual speed windshield wipers with glare-reducing arms and blades; thick laminate windshield; left and right outside mirrors, except Pickup models—left outside and shatter-resistant breakaway inside day-night mirror on Pickup models; backup lights on Pickup and Stake models; seat belts; energy-absorbing steering column; passenger-guard door locks; front seat back lock; corrosion-resistant brake lines; soft, low profile window control knobs; and safety door latches and hinges.

Vehicles shown illustrate standard or optional factory installed equipment. Items referred to as options, optional or available are at extra cost.



GMC's striking new 1967 models are fashioned with the family in mind, but when they pull up to a piece of work, GMC muscles take over. These new models are closer to the ground for smart appearance, closer to the family car in comfort. Smooth, athletic lines hint of the stamina that's built in. Under the skin, these GMC's are all truck!

Even the handsome styling works for you. On the go, air flowing over the sculptured hood carries road splash and dust away from the windows.

Dual headlights keep you in-the-know at night. When you lift the hood, it's an easy reach to anything that may need service.

Inside the new cab, GMC caters to your comfort with extra room and a wide selection of interior trim options.

There's the business-like Deluxe, the stylish Custom and the luxurious Super Custom. New GMC toughness shows in features such as one-piece fender splash shields. They surround the wheels to protect the under-side of fenders from corrosion and flying stones.

Take a good look at the newest trucks on the road. Take a test hop in one of these new GMC's!

BUILT, SOLD & SERVICED BY TRUCK PEOPLE!

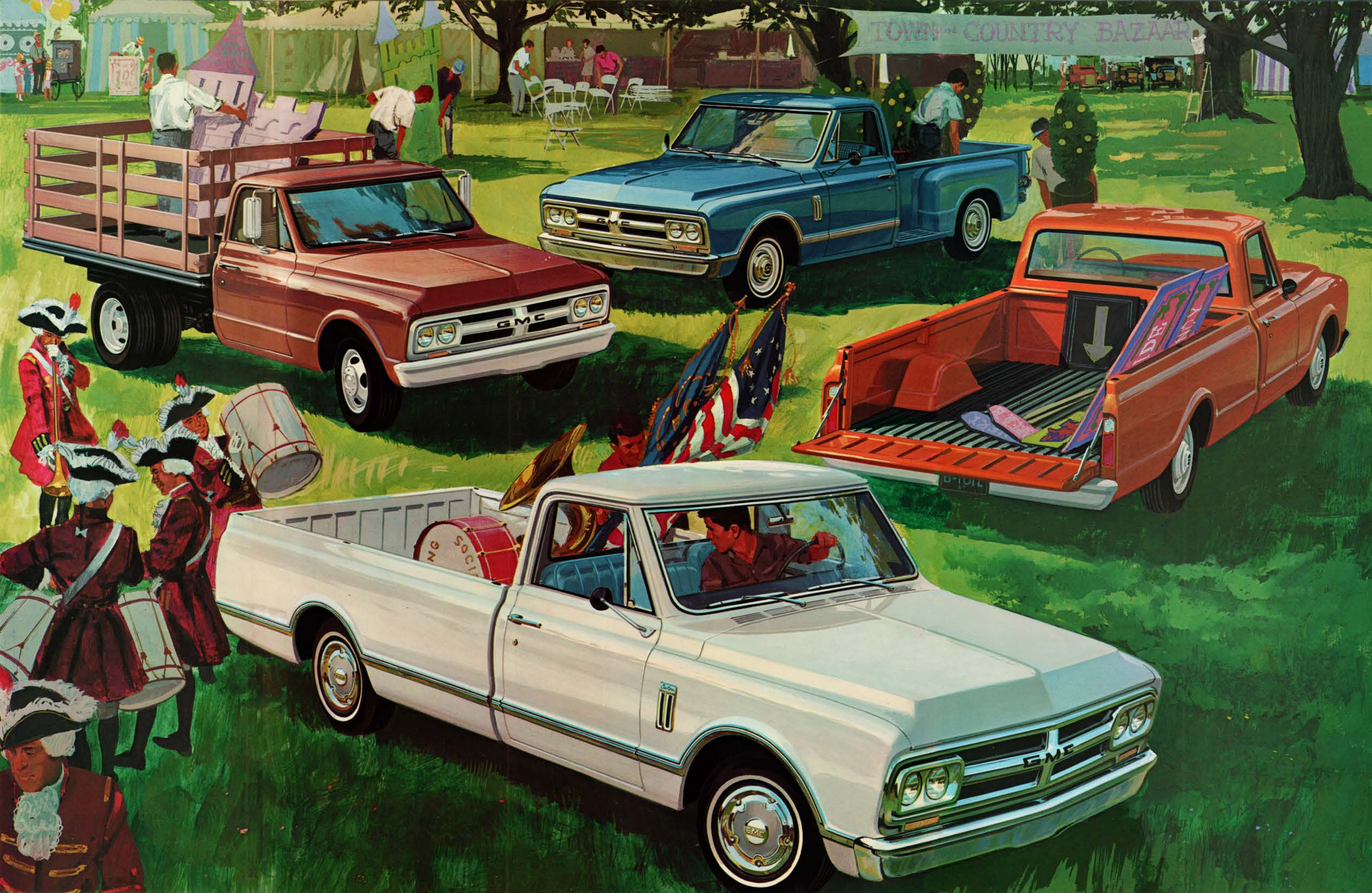

GMC's striking new 1967 models are fashioned with the family in mind, but when they pull up to a piece of work, GMC muscles take over. These new models are closer to the ground for smart appearance, closer to the family car in comfort. Smooth, athletic lines hint of the stamina that's built in. Under the skin, these GMC's are all truck!

Even the handsome styling works for you. On the go, air flowing over the sculptured hood carries road splash and dust away from the windows.

Dual headlights keep you in-the-know at night. When you lift the hood, it's an easy reach to anything that may need service.

Inside the new cab, GMC caters to your comfort with extra room and a wide selection of interior trim options.

There's the business-like Deluxe, the stylish Custom and the luxurious Super Custom. New GMC toughness shows in features such as one-piece fender splash shields. They surround the wheels to protect the under-side of fenders from corrosion and flying stones.

Take a good look at the newest trucks on the road. Take a test hop in one of these new GMC's!

BUILT, SOLD & SERVICED BY TRUCK PEOPLE!



NEW WIDE-SIDE FEATURES

One convenient recessed handle opens the GMC tailgate . . . and it's held shut by easy-closing spring-loaded latches.

Sturdy hinged steel straps support both ends of the full-width, double-walled tailgate. It fits snugly when closed, flush with the deck when open.

Double-wall construction, which extends the full height of GMC's all-new pickup boxes, adds strength and protects the outside appearance.



GMC makes it easy to get the right pickup, stake or cab-and-chassis for your job!

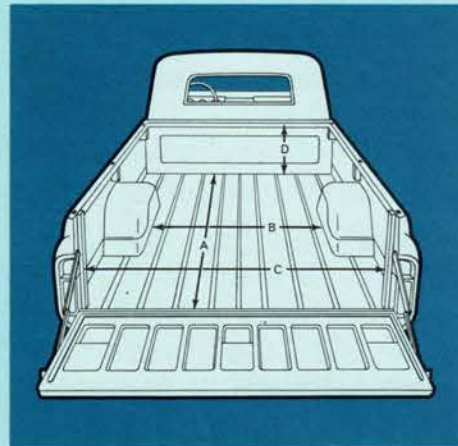

Redesigned Wide-Side bodies offer full-width, high-capacity cargo space with double-wall side panels.

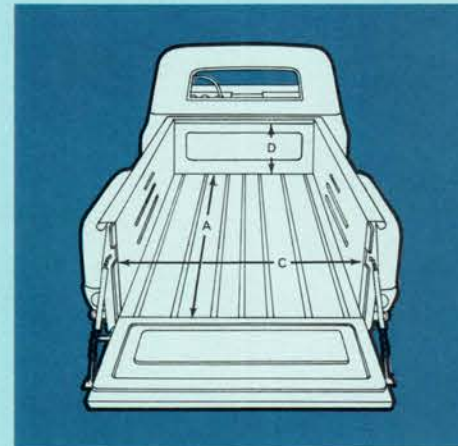

Fenderside bodies provide unobstructed load space and convenient curb-side access from side steps.

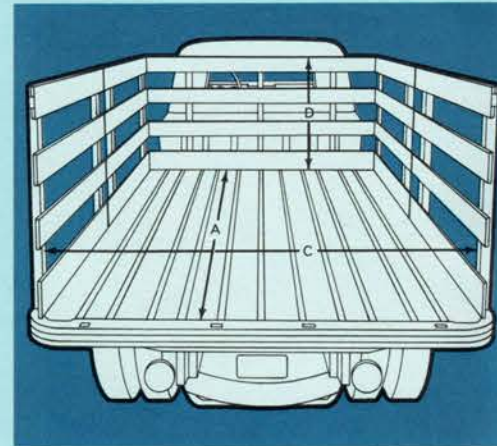

Stake bodies feature heavy steel rub-rails, recessed steel skid-strips and interlocking steel hardware.

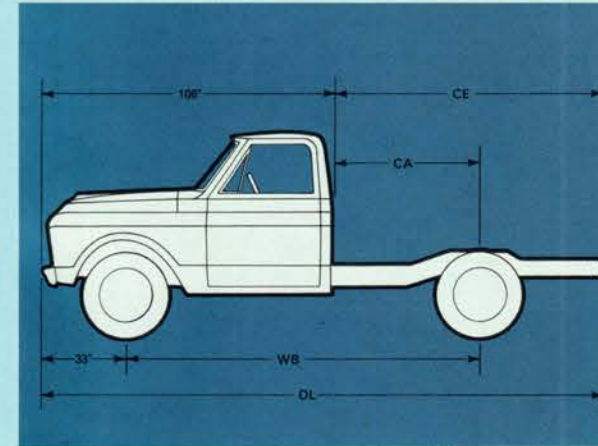

Cab-and-chassis models offer all the style and comfort you want and provide the ideal base for special bodies or equipment.

DIMENSIONS	WIDE-SIDE PICKUP			FENDERSIDE PICKUP				STAKE	
	CM-1500 CS-1500	CM-1500 CS-1500	CM-2500 CS-2500	CM-1500 CS-1500	CM-1500 CS-1500	CM-2500 CS-2500	CM-3500 CS-3500	CM-2500 CS-2500	CM-3500 CS-3500
WB Wheelbase	115"	127"	127"	115"	127"	127"	133"	127"	133"
Nominal Body Length	6½'	8'	8'	6½'	8'	8'	9'	8'	9'
A Inside Length	78½"	98"	98"	78½"	98"	98"	108½"	98"	109"
B Width Between Wheelhousings	50"	50"	50"	—	—	—	—	—	—
C Tailgate Opening	65"	65"	65"	50"	50"	50"	50"	73"	85"
D Inside Height	19¼"	19¼"	19¼"	17¾"	17¾"	17¾"	17¾"	28"	42"

CHASSIS DIMENSIONS	CM-1500 CS-1500 KM-1500	CM-1500 CS-1500 KM-1500 CM-2500 CS-2500 KM-2500	CM-3500	CM-3500
WB—Wheelbase	115"	127"	133"	157"
CA—Std. Cab to Rear Axle	42"	54"	60"	84"
CE—Std. Cab to End of Frame	75½"	95½"	107"	131"
OL—Bumper to End of Frame	180¼"	200½"	211¼"	235¾"



Your fun can be more fun with a GMC Camper Cruiser

GMC pickups or cab-and-chassis units provide a handsome, hard-working base for camper bodies or camping equipment. However, each of the many types of camper equipment automatically affects the riding and handling characteristics of any truck. For this reason, it is *essential* that you select the proper optional tires, wheels, suspensions and axles. In addition, the type of camper traveling you plan may suggest options such as a higher horsepower engine or heavy-duty cooling system, clutch, brakes or transmission. Your GMC dealer can provide all the details on the many GMC options that will adapt a GMC Camper Cruiser to your equipment. Make your camping days more fun, more worry-free with the *right* GMC.

The equipment listed is Required Minimum Equipment for a GMC truck to be identified by the official "Camper Cruiser" nameplate.

Models CM-2500 and CS-2500
Wide-Side or Fenderside body, heavy-duty front and rear springs, front torsion stabilizer, 4-speed manual or 3-speed automatic transmission, heavy-duty cooling, 16 x 6.00G wheels and 7.50/16, 8 p.r. tube-type tires.

Models CM-3500 and CS-3500
Heavy-duty front and rear springs, front torsion stabilizer, heavy-duty front and rear shock absorbers, heavy-duty cooling, 17 x 6.0 wheels and 7.50/17, 10 p.r. tube-type tires for Fenderside models or 18 x 5.0 wheels and 7.00/18, 8 p.r. tube-type front and dual rear tires for chassis-cab models.

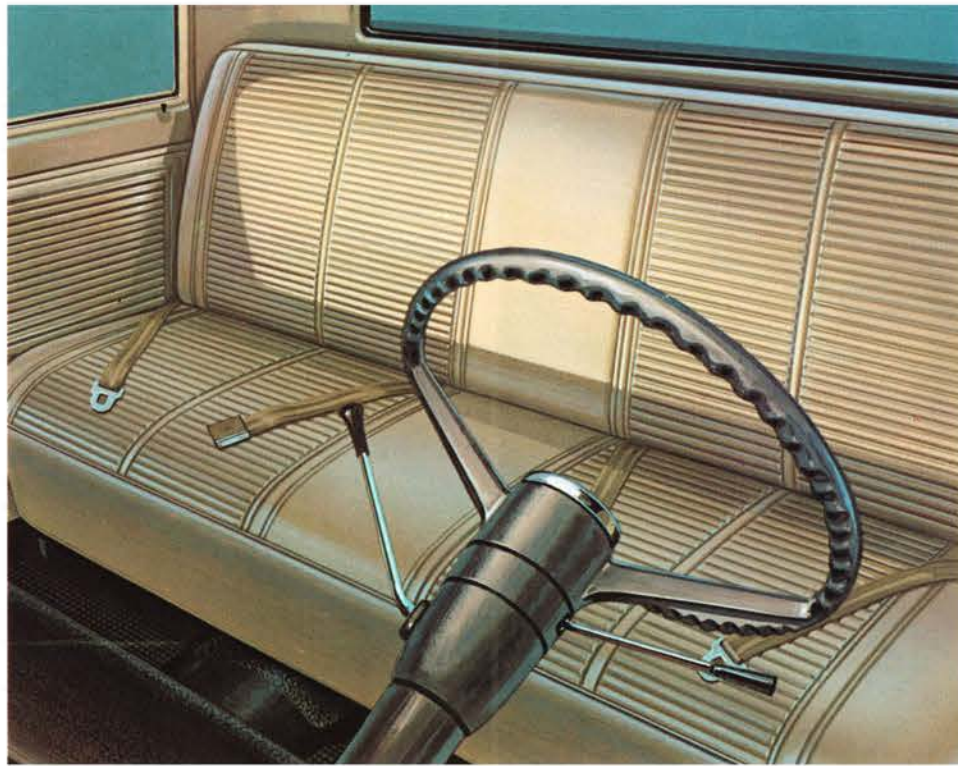

Deluxe cab interiors are among the standard GMC advantages. Tough, washable vinyl is deeply embossed and mounted over thick foam pad to provide exceptional comfort. Seats and seat backs are adjustable to the most comfortable driving position.



Custom cab interiors include handsome woven nylon over full-depth foam cushion, padded vinyl door panels, arm rests, two sun visors and a number of convenience items. Custom interiors are also color keyed to harmonize with the cab color you select.



Super Custom interiors offer the ultimate in comfort and style, including plush bucket seats with center seat console. The Super Custom also includes options from special horn button to carpeted floor.

Set your own style with GMC appearance options!



To accent the GMC style . . . and to add the finishing touches to your GMC pickup, stylish chrome, bright molding and special paint treatment come in a variety of extra-cost combinations. Bumpers, grille, headlight bezels, molding strips, hub caps, wheel covers, and emblems are among the special trim options that will emphasize the contemporary lines of your GMC.



GMC's handsome new padded instrument panel is contoured and finished to minimize glare. Flat knobs, recessed instruments and indented ashtray pull offer a new standard of safety.

V engines for
"right now" power,
long-distance
savings!

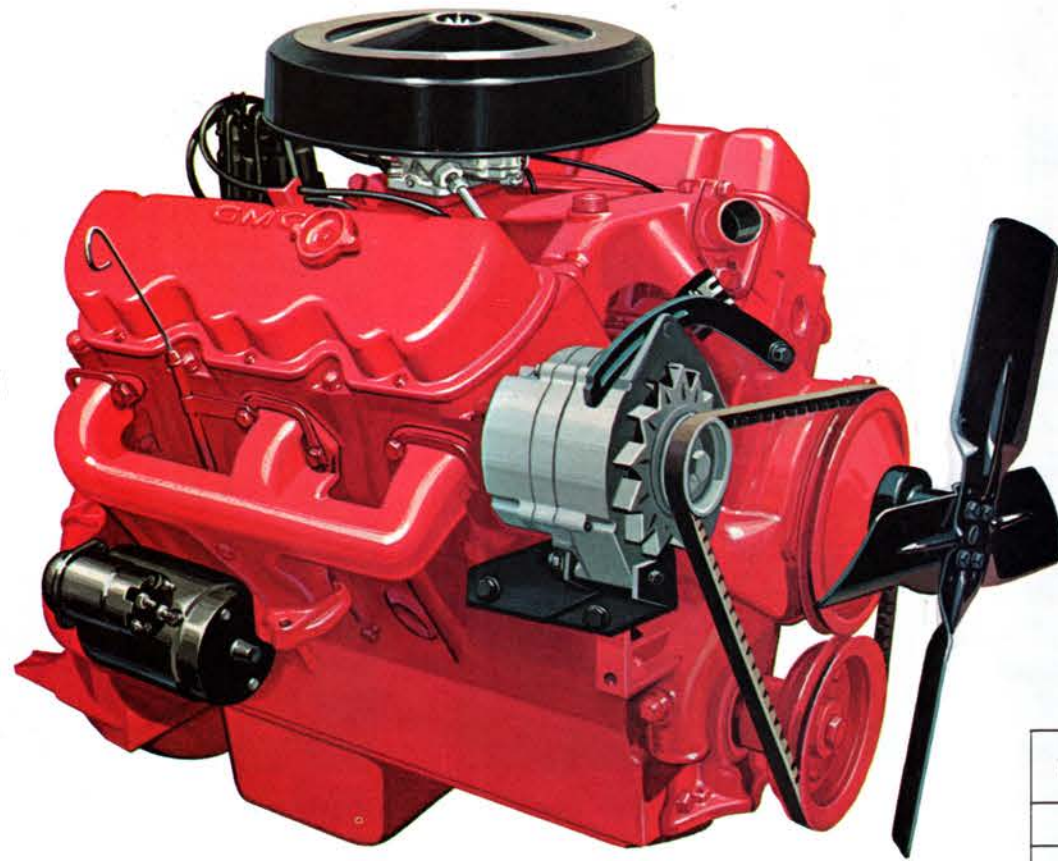

When you put a big GMC V-6 under your hood, you put real truck power at your command. Well over a half million GMC V-6's have already taken to the road to establish them as the toughest, most modern powerplants in the business. Their durability is beyond question. They often do *twice* the work of comparable engines before a major repair is needed. And best of all, these true truck engines cost less than you think!

In the V-6 engines, GMC developed a family of powerplants that work at low engine speeds to save wear on moving parts. Their short-stroke, over-square design holds friction to a minimum while unusually high-volume cooling and lubrication systems make sure they stay cool and smooth, mile after mile.

GMC's V-6's work at saving you money on every mile, too. They thrive on regular-grade gasoline!

In the 305E, with 170 horsepower, there's more than ample action for most light-tonnage haulers. If high performance is your style, the 351E, with 220 horsepower, may be your choice.

Here are some V-6 design features that lead to thousands of miles of dependable service:

- Compact 60-degree V-block, with deep ribbed skirt extending well below centerline of crankshaft
- short, rigid crankshaft
- sturdy I-beam connecting rods
- cast aluminum pistons with integral steel expansion control band
- over-square design, with cylinder bore greater than piston stroke for less piston travel
- positive crankcase ventilation.

ENGINE	HORSEPOWER		TORQUE (lbs.-ft.)		DISPLACEMENT	BORE AND STROKE	COMP. RATIO
	GROSS	NET	GROSS	NET			
305E	170 @ 4000 rpm.	157 @ 4000 rpm.	277 @ 1600 rpm.	263 @ 1600 rpm.	304.7 cu. in.	4.25" x 3.58"	7.75 to 1
351E	220 @ 4000 rpm.	190 @ 3700 rpm.	320 @ 1600 rpm.	304 @ 1600 rpm.	351.2 cu. in.	4.56" x 3.58"	7.50 to 1

In-line
engines for
economy from
the start!

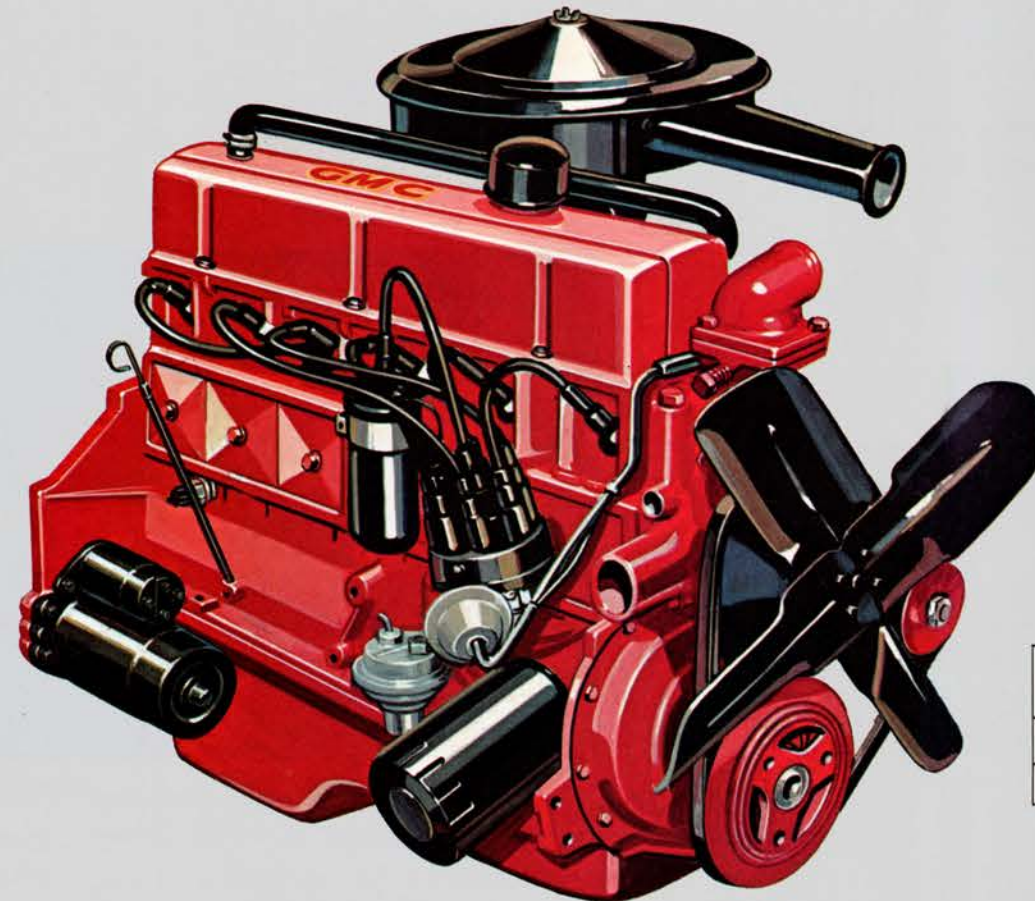

Looking for a way to hold the economy line? There's no better way than one of the in-line Six engines in the GMC line! A big 250-cubic-inch in-line, standard in CS-Series GMCs, is conservatively rated at 155 horsepower. For even greater performance, the 292-cubic-inch in-line with 170 horsepower is optional on most light-tonnage models. These proved powerplants are designed to put you on the economy trail by making the most of every drop of regular grade gasoline. That means economy from the start!

Here are some of the in-line Six features that keep the GMC CS-Series working smoother, longer:

- Seven main bearings keep bearing unit pressure low, provide large supporting surfaces for crankshaft
- dynamically balanced crankshaft virtually eliminates vibration
- positive crankcase ventilation flushes corrosive acid fumes out of the crankcase, burns them in the combustion process
- precision-cast block trims weight and gives extra strength in high-stress areas
- Full-length water jackets extend cylinder wall life.

ENGINE	HORSEPOWER		TORQUE (lbs.-ft.)		DISPLACEMENT	BORE AND STROKE	COMP. RATIO
	GROSS	NET	GROSS	NET			
250	155 @ 4200 rpm.	125 @ 3800 rpm.	235 @ 1600 rpm.	220 @ 1600 rpm.	250 cu. in.	3.87" x 3.53"	8.50 to 1
292	170 @ 4000 rpm.	153 @ 3600 rpm.	275 @ 1600 rpm.	255 @ 2400 rpm.	292 cu. in.	3.87" x 4.12"	8.00 to 1

The GMC chassis...

where your work ends up...

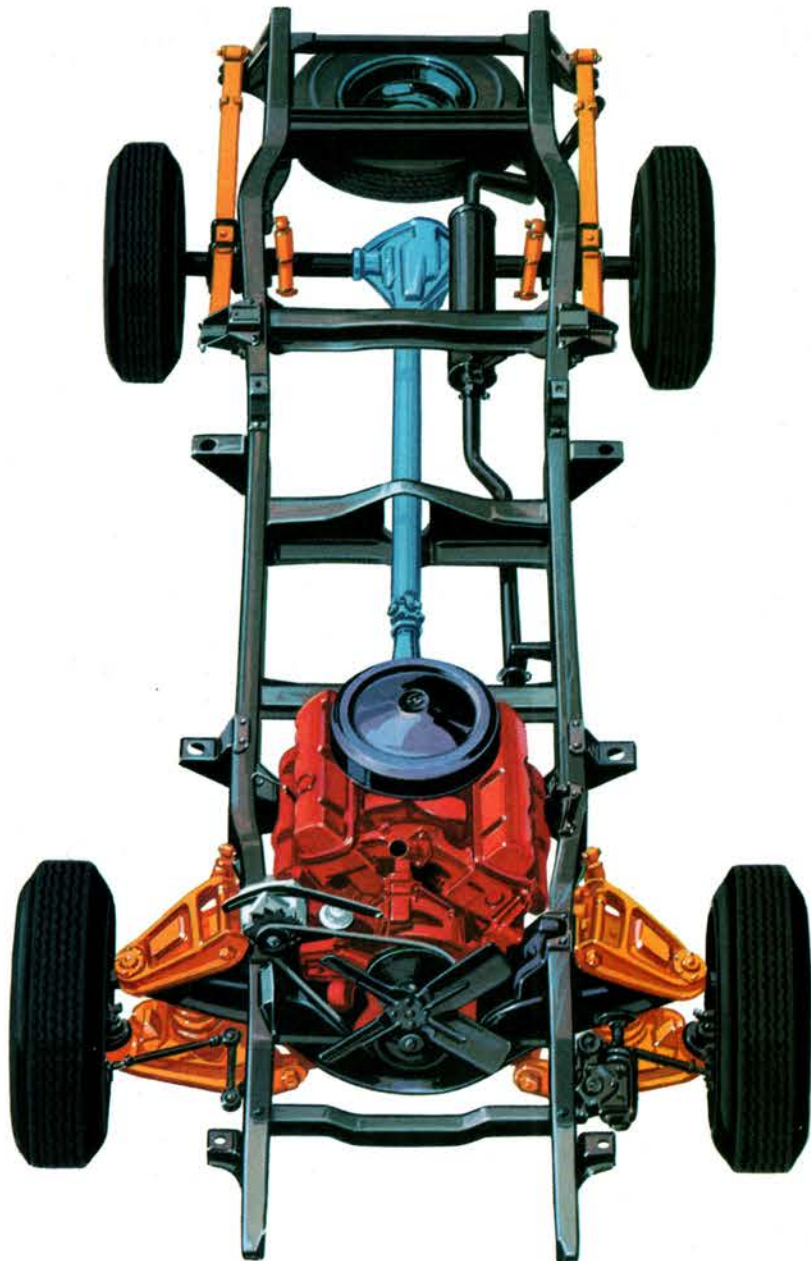

Frames—Your GMC will have the full support of rugged, steel-channel frame rails. Sturdy crossmembers supply extra rigidity, extra strength to the rugged GMC understructure.

Rear Axles—Smooth, quiet operation of hypoid rear axles comes from greater gear-tooth contact. Fast ratios, standard with V-6 engines, give you the economy of overdrive without the extra cost. Maximum traction differential is also available.

Brakes—Brake adjusting is automatic during the entire life of your brake lining. And now, a dual brake system with separate master cylinders for front and rear brakes is standard on most GMC light-tonnage models. This means even greater dependability. Power brakes are available if you need more than average braking power.

Steering—It's easier to handle a GMC because a recirculating-ball steering system is standard. Polished ball bearings are always rolling between the working surfaces to cut friction. Power steering is available as an extra-cost option.

Clutches—To match your GMC engine, long-life, single-plate clutches will handle capacity loads under average operating conditions. For off-road, mountainous or stop-and-go operations, oversize clutches are available.

Transmissions—When you choose a GMC, you can select the gear system that will provide the best blend of economy and performance on your job. When you have the proper ratios, driving is easiest and engine performance is at its peak.

Series 1500 and 2500 are served well by

where your comfort begins!

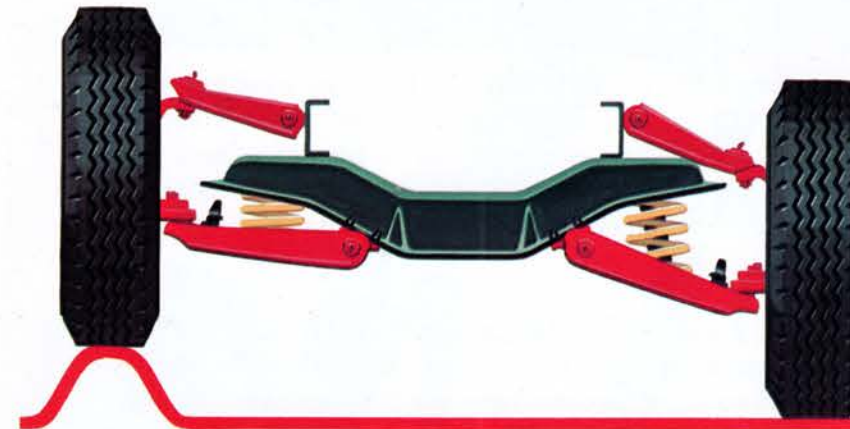
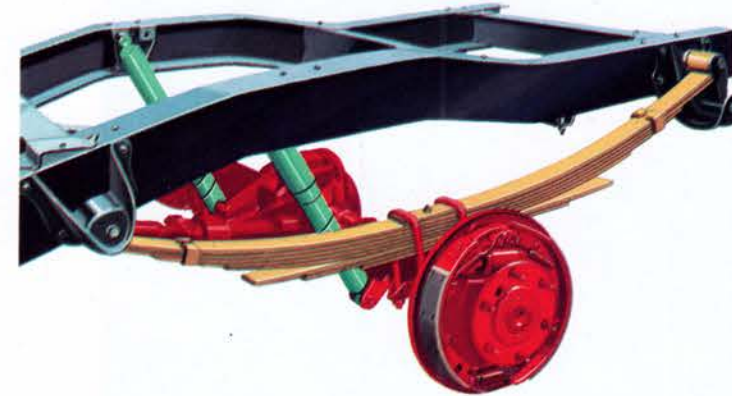

Only GMC offers the comfort of coil springs in front with the stability of leaf rear springs in a balanced package, to produce the easiest driving, smoothest riding trucks in their class.

Progressive Leaf Rear Suspension—Whether your GMC load is heavy or light, it will get gentle treatment. The big leaf springs tailor themselves to load weight. Low-mounted shock absorbers (standard on 1500 and 2500 Series, optional on 3500 Series) contribute to exceptional load cushioning and stability.

Independent Front Suspension—GMC's IFS with coil springs makes every road smoother, every turn easier to take. Each front wheel keeps road shock to itself, keeps frame twist at a minimum to protect you, your load, and your truck. It's a perfect match for GMC's rear leaf suspension.

the standard 3-speed manual transmission, with the shift lever mounted conveniently on the steering column. For the 3500 Series, a rugged 4-speed floor-shift transmission is standard. It offers a convenient power take-off opening for operation of winches, lift gates or other power equipment. This 4-speed is an extra-cost option on Series 1500 and 2500.

If your load or driving conditions demand high torque most of the time, an optional

4-speed with lower ratios will give you closer gear steps, longer transmission life. A power take-off opening is also provided with this transmission.

Automatic transmissions can bring added pleasure to your driving in Series 1500 and 2500. A 2-speed Pow-R-Flow or 3-speed Turbo-Hydramatic will also protect your engine and driveline from shifting shock. Ask about specific model application.

The GMC chassis...

... where your work ends up...

Get down-to-earth style, back-woods ground clearance with GMC 4-wheel-drive models!

Frames—Your GMC will have the full support of rugged, steel-channel frame rails. Sturdy crossmembers supply extra rigidity, extra strength to the rugged GMC understructure.

Rear Axles—Smooth, quiet operation of hypoid rear axles comes from greater gear-tooth contact. Fast ratios, standard with V-6 engines, give you the economy of overdrive without the extra cost. Maximum traction differential is also available.

Brakes—Brake adjusting is automatic during the entire life of your brake lining. And now, a dual brake system with separate master cylinders for front and rear brakes is standard on most GMC light-tonnage models. This means even greater dependability. Power brakes are available if you need more than average braking power.

Steering—It's easier to handle a GMC because a recirculating-ball steering system is standard. Polished ball bearings are always rolling between the working surfaces to cut friction. Power steering is available as an extra-cost option.

Clutches—To match your GMC engine, long-life, single-plate clutches will handle capacity loads under average operating conditions. For off-road, mountainous or stop-and-go operations, oversize clutches are available.

Transmissions—When you choose a GMC, you can select the gear system that will provide the best blend of economy and performance on your job. When you have the proper ratios, driving is easiest and engine performance is at its peak.

Series 1500 and 2500 are served well by

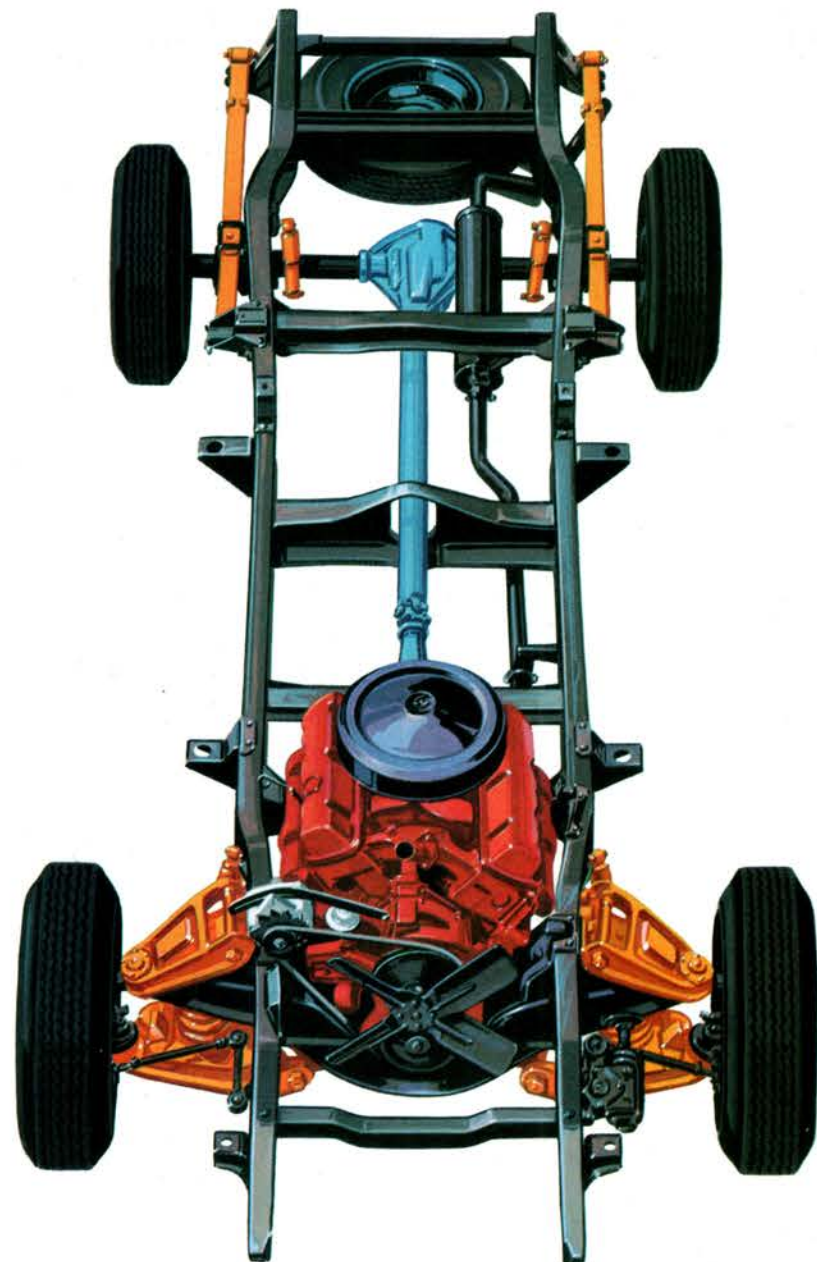

Front driving axle joints provide firm, positive power regardless of turning position. Forward-mounted steering gear and the high position of linkage protect mechanism in rugged terrain. **Tapered leaf springs**, front and rear,

set new standards of 4 x 4 riding comfort. Leaves taper from thick, narrow section at the axle to thinner, wider section at the ends. This reduces friction between leaves and permits use of pin and shackle attachment.



Wherever your job is, wherever the game may be, now you can go with extra ease! Exceptional engineering advances have brought GMC 4-wheel-drive cabs five inches closer to the road while ground

clearance remains as high as tough terrain demands. With the new GMC 4 x 4, it's easy in and easy out!

Six forward speeds, two in reverse, make rough going easy . . . help you

conquer steep inclines, go over terrain you would never try with other trucks. Engine, transmission, transfer case and driving axles work together smoothly, quietly, on or off the road.

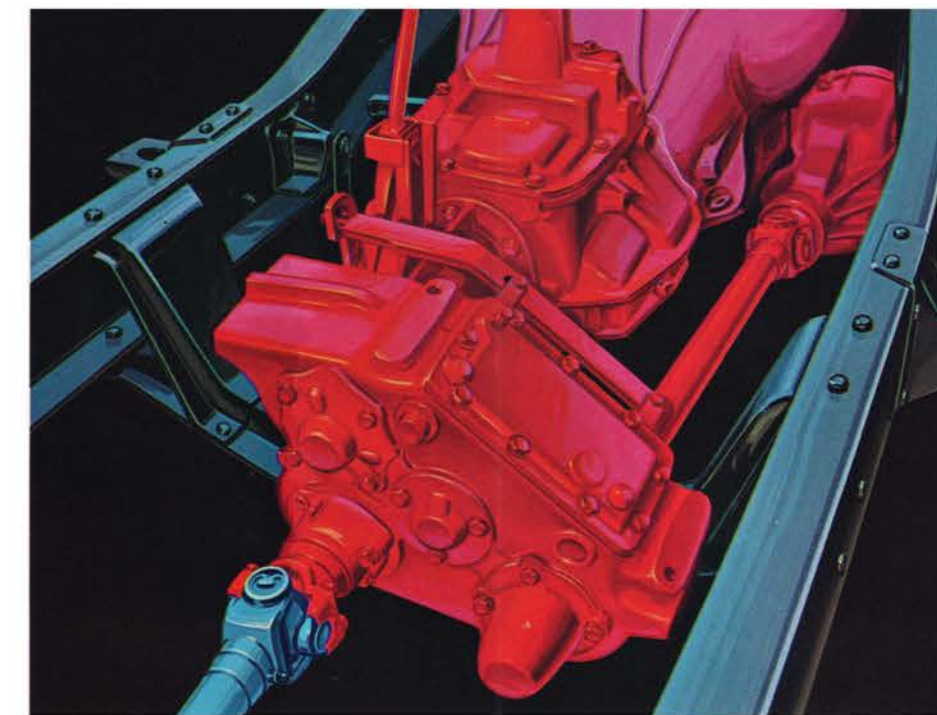

The 2-speed transfer case is bolted directly to the transmission. This eliminates the propeller shaft linkage usually found between the two gear boxes. As a direct result, the GMC cab and body are closer to the ground, making it easier to get in and out. One simple lever from the transfer case controls the engagement of front-wheel drive as well as the high and low ranges. Power take-off openings are provided for accessory drives to the front or rear.

Specifications

SERIES	CM & CS-1500	CM & CS-2500	CM & CS-3500	KM-1500 (4 x 4)	KM-2500 (4 x 4)
GROSS WEIGHT RANGE GVW	4600-5200 lbs.*	5500-7500 lbs.	6700-14,000 lbs.	4600-5600 lbs.	5700-8100 lbs.
AXLE, FRONT IFS 2500 lbs.	STD.	—	—	—	—
3000 lbs.	—	STD.	—	—	—
3500 lbs.	—	—	STD.	—	—
Driving-Steering 3300 lbs.	—	—	—	STD.	—
3500 lbs.	—	—	—	—	STD.
AXLE, REAR 3500 lbs. Spicer 44	STD.	—	—	STD.	—
Spicer 60-35	OPT.	—	—	—	—
5500 lbs. Spicer 60	—	STD.	—	—	STD.
7200 lbs. GMC H-072	—	—	STD.	—	—
11,000 lbs. GMC H-110	—	—	OPT.†	—	—
BRAKES, SERVICE Hydraulic	STD.	STD.	STD.	STD.	STD.
Vacuum-Hydraulic	OPT.	OPT.	OPT.	OPT.	OPT.
CLUTCH 10"	STD. (CS)	STD. (CS)	—	—	—
10½"	STD. (CM)	STD. (CM)	STD. (CM)	—	—
11"	OPT.	OPT.	STD. (CS) OPT. (CM)	STD.	STD.
ENGINE In-Line 155 hp. 250	STD. (CS)	STD. (CS)	STD. (CS)	—	—
170 hp. 292	OPT. (CS)	OPT. (CS)	OPT. (CS)	—	—
V6 170 hp. 305E	STD. (CM)	STD. (CM)	STD. (CM)	STD.	STD.
220 hp. 351E	OPT. (CM)	OPT. (CM)	OPT. (CM)	—	—
FRAME Channel Type	STD.	STD.	STD.	STD.	STD.
SPRINGS, FRONT Coil 1250 lbs.	STD.	—	—	—	—
Rated at Ground 1350 lbs.	—	STD.	—	—	—
1500 lbs.	—	OPT.	STD.	—	—
1750 lbs.	—	—	OPT.	—	—
Tapered Leaf 1650 lbs.	—	—	—	STD.	—
1750 lbs.	—	—	—	—	STD.
SPRINGS, REAR Leaf 1250 lbs.	STD.	—	—	—	—
Rated at Ground 1750 lbs.	OPT.	—	—	—	—
2000 lbs.	—	STD.	—	—	—
2400 lbs.	—	—	STD.	—	—
2700 lbs.	—	OPT.	—	—	—
3100 lbs.	—	—	OPT.	—	—
Auxiliary 1050 lbs.	—	—	OPT.	—	—
Tapered Leaf 1900 lbs.	—	—	—	STD.	STD.
3150 lbs.	—	—	—	—	OPT.
TRANSMISSION 3-speed SM-318	STD. (CS)	—	—	STD.	STD.
SM-326	STD. (CM) OPT. (CS)	STD.	—	—	—
4-speed SM-420	OPT. (CS)	OPT. (CS)	STD. (CS)	OPT.	OPT.
NP-435GA	OPT.	OPT.	STD. (CM) OPT. (CS)	—	—
2-speed Automatic AT-218	OPT.	OPT.	—	—	—
3-speed Automatic AT-400	OPT.	OPT.	—	—	—
TIRES Standard	8.15-15,4 p.r.	7-17.5,6 p.r.	8-17.5,6 p.r. frt., 8 p.r. rr.	8.15-15,4 p.r.	7-17.5,6 p.r.
Maximum	7-17.5,6 p.r.	8-19.5,8 p.r.	8-19.5,10 p.r.	7-17.5,6 p.r.	8-19.5,8 p.r.
WHEELS, DISC	STD.	STD.	STD.	STD.	STD.

*5000 lbs. for CS †Available on 157" WB only. Includes 4000 lb. front axle

Refer to Load Capacity Chart in Data Book or Owners and Drivers Manual for minimum equipment required for maximum GVW or GCW.

The chassis components shown above are available as factory-installed options. Different model applications of these components as well as many other items of factory-installed equipment may be ordered through your GMC Dealer.

GMC Truck & Coach Division reserves the right to make changes at any time without notice in prices, colors, materials, equipment, specifications and models and also to discontinue models. Data shown above is basic information for the prospective buyer as effective at time of issuance of this pamphlet. Dealer will provide complete up-to-date information on options, specifications, etc., not shown here.

GMC TRUCK & COACH DIVISION, GENERAL MOTORS CORPORATION, PONTIAC, MICHIGAN

Litho in U.S.A.—ADV 571—7-66—350M

Specifications

SERIES	CM & CS-1500	CM & CS-2500	CM & CS-3500	KM-1500 (4 x 4)	KM-2500 (4 x 4)
GROSS WEIGHT RANGE GVW	4600-5200 lbs.*	5500-7500 lbs.	6700-14,000 lbs.	4600-5600 lbs.	5700-8100 lbs.
AXLE, FRONT IFS	2500 lbs.	—	—	—	—
	3000 lbs.	—	—	—	—
	3500 lbs.	—	—	—	—
Driving-Steering	3300 lbs.	—	—	—	—
	3500 lbs.	—	—	—	—
AXLE, REAR	3500 lbs.	—	—	—	—
	Spicer 44	—	—	—	—
	Spicer 60-35	—	—	—	—
	5500 lbs. Spicer 60	—	—	—	—
	7200 lbs. GMC H-072	—	—	—	—
	11,000 lbs. GMC H-110	—	—	—	—
BRAKES, SERVICE	Hydraulic	—	—	—	—
	Vacuum-Hydraulic	—	—	—	—
CLUTCH	10"	—	—	—	—
	10½"	—	—	—	—
	11"	—	—	—	—
ENGINE In-Line	155 hp. 250	—	—	—	—
	170 hp. 292	—	—	—	—
V6	170 hp. 305E	—	—	—	—
	220 hp. 351E	—	—	—	—
FRAME	Channel Type	—	—	—	—
SPRINGS, FRONT	Coil	—	—	—	—
Rated at Ground	1250 lbs.	—	—	—	—
	1350 lbs.	—	—	—	—
	1500 lbs.	—	—	—	—
	1750 lbs.	—	—	—	—
Tapered Leaf	1650 lbs.	—	—	—	—
	1750 lbs.	—	—	—	—
SPRINGS, REAR	Leaf	—	—	—	—
Rated at Ground	1250 lbs.	—	—	—	—
	1750 lbs.	—	—	—	—
	2000 lbs.	—	—	—	—
	2400 lbs.	—	—	—	—
	2700 lbs.	—	—	—	—
	3100 lbs.	—	—	—	—
Auxiliary	1050 lbs.	—	—	—	—
Tapered Leaf	1900 lbs.	—	—	—	—
	3150 lbs.	—	—	—	—
TRANSMISSION	3-speed	—	—	—	—
	SM-318	—	—	—	—
	SM-326	—	—	—	—
4-speed	SM-420	—	—	—	—
	NP-435GA	—	—	—	—
2-speed Automatic	AT-218	—	—	—	—
3-speed Automatic	AT-400	—	—	—	—
TIRES Standard	8.15-15,4 p.r.	7-17.5,6 p.r.	8-17.5,6 p.r. frt., 8 p.r. rr.	8.15-15,4 p.r.	7-17.5,6 p.r.
Maximum	7-17.5,6 p.r.	8-19.5,8 p.r.	8-19.5,10 p.r.	7-17.5,6 p.r.	8-19.5,8 p.r.
WHEELS, DISC	STD.	STD.	STD.	STD.	STD.

*5000 lbs. for CS †Available on 157" WB only. Includes 4000 lb. front axle

Refer to Load Capacity Chart in Data Book or Owners and Drivers Manual for minimum equipment required for maximum GVW or GCW.

The chassis components shown above are available as factory-installed options. Different model applications of these components as well as many other items of factory-installed equipment may be ordered through your GMC Dealer.

GMC Truck & Coach Division reserves the right to make changes at any time without notice in prices, colors, materials, equipment, specifications and models and also to discontinue models. Data shown above is basic information for the prospective buyer as effective at time of issuance of this pamphlet. Dealer will provide complete up-to-date information on options, specifications, etc., not shown here.

GMC TRUCK & COACH DIVISION, GENERAL MOTORS CORPORATION, PONTIAC, MICHIGAN

Litho in U.S.A.—ADV 571—7-66—350M



where your comfort begins!

Only GMC offers the comfort of coil springs in front with the stability of leaf rear springs in a balanced package, to produce the easiest driving, smoothest riding trucks in their class.

Progressive Leaf Rear Suspension— Whether your GMC load is heavy or light, it will get gentle treatment. The big leaf springs tailor themselves to load weight. Low-mounted shock absorbers (standard on 1500 and 2500 Series, optional on 3500 Series) contribute to exceptional load cushioning and stability.

Independent Front Suspension — GMC's IFS with coil springs makes every road smoother, every turn easier to take. Each front wheel keeps road shock to itself, keeps frame twist at a minimum to protect you, your load, and your truck. It's a perfect match for GMC's rear leaf suspension.

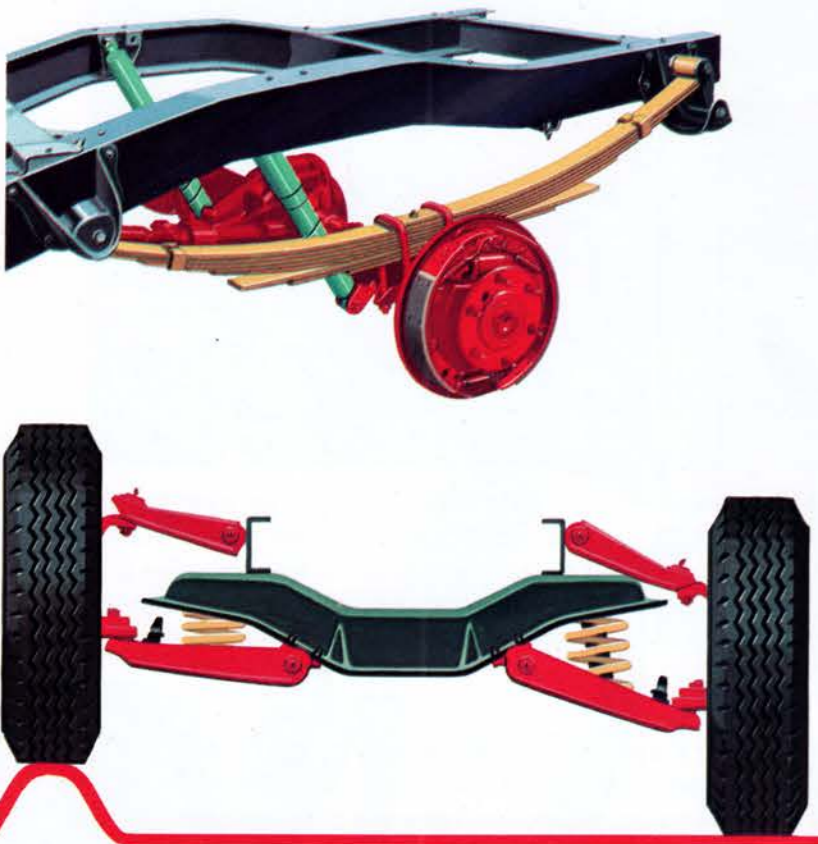

the standard 3-speed manual transmission, with the shift lever mounted conveniently on the steering column. For the 3500 Series, a rugged 4-speed floor-shift transmission is standard. It offers a convenient power take-off opening for operation of winches, lift gates or other power equipment. This 4-speed is an extra-cost option on Series 1500 and 2500.

If your load or driving conditions demand high torque most of the time, an optional

4-speed with lower ratios will give you closer gear steps, longer transmission life. A power take-off opening is also provided with this transmission.

Automatic transmissions can bring added pleasure to your driving in Series 1500 and 2500. A 2-speed Pow-R-Flow or 3-speed Turbo-Hydrumatic will also protect your engine and driveline from shifting shock. Ask about specific model application.

Specifications

SERIES		CM & CS-1500	CM & CS-2500	CM & CS-3500	KM-1500 (4 x 4)	KM-2500 (4 x 4)
GROSS WEIGHT RANGE GVW		4600-5200 lbs.*	5500-7500 lbs.	6700-14,000 lbs.	4600-5600 lbs.	5700-8100 lbs.
AXLE, FRONT IFS	2500 lbs.	STD.	—	—	—	—
	3000 lbs.	—	STD.	—	—	—
	3500 lbs.	—	—	STD.	—	—
Driving-Steering	3300 lbs.	—	—	—	STD.	—
	3500 lbs.	—	—	—	—	STD.
AXLE, REAR	3500 lbs. Spicer 44	STD.	—	—	STD.	—
	Spicer 60-35	OPT.	—	—	—	—
	5500 lbs. Spicer 60	—	STD.	—	—	STD.
	7200 lbs. GMC H-072	—	—	STD.	—	—
	11,000 lbs. GMC H-110	—	—	OPT.†	—	—
BRAKES, SERVICE	Hydraulic	STD.	STD.	STD.	STD.	STD.
	Vacuum-Hydraulic	OPT.	OPT.	OPT.	OPT.	OPT.
CLUTCH	10"	STD. (CS)	STD. (CS)	—	—	—
	10½"	STD. (CM)	STD. (CM)	STD. (CM)	—	—
	11"	OPT.	OPT.	STD. (CS) OPT. (CM)	STD.	STD.
ENGINE	In-Line 155 hp. 250	STD. (CS)	STD. (CS)	STD. (CS)	—	—
	170 hp. 292	OPT. (CS)	OPT. (CS)	OPT. (CS)	—	—
	V6 170 hp. 305E	STD. (CM)	STD. (CM)	STD. (CM)	STD.	STD.
	220 hp. 351E	OPT. (CM)	OPT. (CM)	OPT. (CM)	—	—
FRAME	Channel Type	STD.	STD.	STD.	STD.	STD.
SPRINGS, FRONT	Coil 1250 lbs.	STD.	—	—	—	—
Rated at Ground	1350 lbs.	—	STD.	—	—	—
	1500 lbs.	—	OPT.	STD.	—	—
	1750 lbs.	—	—	OPT.	—	—
	Tapered Leaf 1850 lbs.	—	—	—	STD.	—
	1750 lbs.	—	—	—	—	STD.
SPRINGS, REAR	Leaf 1250 lbs.	STD.	—	—	—	—
Rated at Ground	1750 lbs.	OPT.	—	—	—	—
	2000 lbs.	—	STD.	—	—	—
	2400 lbs.	—	—	STD.	—	—
	2700 lbs.	—	OPT.	—	—	—
	3100 lbs.	—	—	OPT.	—	—
	Auxiliary 1050 lbs.	—	—	OPT.	—	—
	Tapered Leaf 1900 lbs.	—	—	—	STD.	STD.
	3150 lbs.	—	—	—	—	OPT.
TRANSMISSION	3-speed SM-318	STD. (CS)	—	—	STD.	STD.
	SM-326	STD. (CM) OPT. (CS)	STD.	—	—	—
	4-speed SM-420	OPT. (CS)	OPT. (CS)	STD. (CS)	OPT.	OPT.
	NP-435GA	OPT.	OPT.	STD. (CM) OPT. (CS)	—	—
	2-speed Automatic AT-218	OPT.	OPT.	—	—	—
	3-speed Automatic AT-400	OPT.	OPT.	—	—	—
TIRES	Standard	8.15-15.4 p.r.	7-17.5,6 p.r.	8-17.5,6 p.r. frt., 8 p.r. rr.	8.15-15.4 p.r.	7-17.5,6 p.r.
	Maximum	7-17.5,6 p.r.	8-19.5,8 p.r.	8-19.5,10 p.r.	7-17.5,6 p.r.	8-19.5,8 p.r.
WHEELS, DISC		STD.	STD.	STD.	STD.	STD.

*5000 lbs. for CS †Available on 157" WB only. Includes 4000 lb. front axle
Refer to Load Capacity Chart in Data Book or Owners and Drivers Manual for minimum equipment required for maximum GVW or GCW.

The chassis components shown above are available as factory-installed options. Different model applications of these components as well as many other items of factory-installed equipment may be ordered through your GMC Dealer.

GMC Truck & Coach Division reserves the right to make changes at any time without notice in prices, colors, materials, equipment, specifications and models and also to discontinue models. Data shown above is basic information for the prospective buyer as effective at time of issuance of this pamphlet. Dealer will provide complete up-to-date information on options, specifications, etc., not shown here.

GMC TRUCK & COACH DIVISION, GENERAL MOTORS CORPORATION, PONTIAC, MICHIGAN

Litho in U.S.A.—ADV 571—7-66—350M



The all-new line of GMC light-tonnage trucks...

For your greater convenience and safety, the following items are standard equipment on GMC's 1967 Light-Tonnage models (except cowl models): Instrument panel—padded edge, glare-reducing paint on crown, textured instrument background, flat knobs, safety-pull ashtray and safety latch glove box door; front seat shoulder belt anchors; padded sun visor; four-way hazard warning flasher; dual master cylinder brake system; windshield washer; dual speed windshield wipers with glare-reducing arms and blades; thick laminate windshield; left and right outside mirrors, except Pickup models—left outside and shatter-resistant breakaway inside day-night mirror on Pickup models; backup lights on Pickup and Stake models; seat belts; energy-absorbing steering column; passenger-guard door locks; front seat back lock; corrosion-resistant brake lines; soft, low profile window control knobs; and safety door latches and hinges.

Vehicles shown illustrate standard or optional factory installed equipment. Items referred to as options, optional or available are at extra cost.