



'67  OLDSMOBILE

*The Rocket Action Cars are Out Front Again!*

***This is the Oldsmobile story for 1967 . . .***

*A story of what's new and what's now; what's fun and what's fashionable; what's young and what's you about Olds this year. In it you'll get a full introduction to 36 new quality-built Oldsmobiles. You'll meet the inimitable classic-in-its-own-time—Toronado, '67 edition. Five alluring new Ninety-Eights. A new Delta 88 lineup, where two new Delta Custom models share honors for elegance. A brand-new Rocket series with a brand-new name—Delmont 88. Five Cutlass Supreme models (five, mind you, for 1967). Plus saucy new Cutlass models. Sassy new F-85s. Sporty new 4-4-2s. And a vivaciously versatile new group of Vista-Cruiser, Cutlass and F-85 Station Wagons. All earmarked with the kind of quality and engineering leadership you expect from the originator of famed front-wheel-drive Toronado. You'll discover a whole new state of thoughtfully engineered Olds safety features, too:*

- |  |  |
|--|--|
| <ul style="list-style-type: none"> <li>Padded instrument panel</li> <li>Padded sun visors</li> <li>Energy-absorbing instrument panel with smooth contoured knobs and levers</li> <li>Four-way hazard warning flasher</li> <li>Backup lights</li> <li>Dual master cylinder brake system with warning light</li> <li>Dual-speed windshield wipers</li> <li>Windshield washer</li> <li>Outside rearview mirror</li> <li>Tire safety rim</li> <li>Seat belts (front and rear) with pushbutton buckles</li> <li>Front seat belt retractors</li> <li>Front seat shoulder belt anchors</li> <li>Energy-absorbing steering column</li> </ul> | <ul style="list-style-type: none"> <li>Energy-absorbing steering wheel</li> <li>Folding-front-seat-back latches (two-door models)</li> <li>Folding-seat-back latches (wagons)</li> <li>Inside day-night mirror with shatter-resistant, vinyl-edged glass and breakaway support</li> <li>Lane change feature in direction-signal control</li> <li>Corrosion-resistant brake lines</li> <li>Soft, low-profile window control knobs and coat hooks</li> <li>Safety door latches and hinges</li> <li>Passenger-guard door locks—all doors</li> <li>Uniform shift quadrant (PRNDL)</li> <li>Thick laminate windshield</li> <li>Reduced glare instrument panel and windshield wiper arms and blades</li> </ul> |
|--|--|

**Obey  
Laws  
Drive  
Safely** *These features were designed for your safety and convenience. We want you to enjoy the pleasures of Olds travel for years to come! All in all, this is a complete new story about the brilliantly new Oldsmobiles. And we think you'll agree it clearly demonstrates: Oldsmobile for '67 is engineered for excitement . . . Toronado-style!*

- Toronado . . . . . Page 4
- Ninety-Eight . . . . . Page 8
- Delta 88 Custom . . . . . Page 14
- Delta 88 . . . . . Page 18
- Delmont 88 . . . . . Page 22
- Cutlass Supreme . . . . . Page 26
- Cutlass . . . . . Page 30
- F-85 . . . . . Page 32
- 4-4-2 . . . . . Page 34
- Vista-Cruiser Station Wagon . . . . . Page 36
- Cutlass and F-85 Station Wagons . . . . . Page 38
- Engine-Transmission Features . . . . . Page 40
- Chassis Features . . . . . Page 42
- Safety Features . . . . . Page 3, 43
- Glossary of Models . . . . . Page 44
- Options—Accessories . . . . . Page 46
- Specifications . . . . . Page 48

# '67 OLDSMOBILE

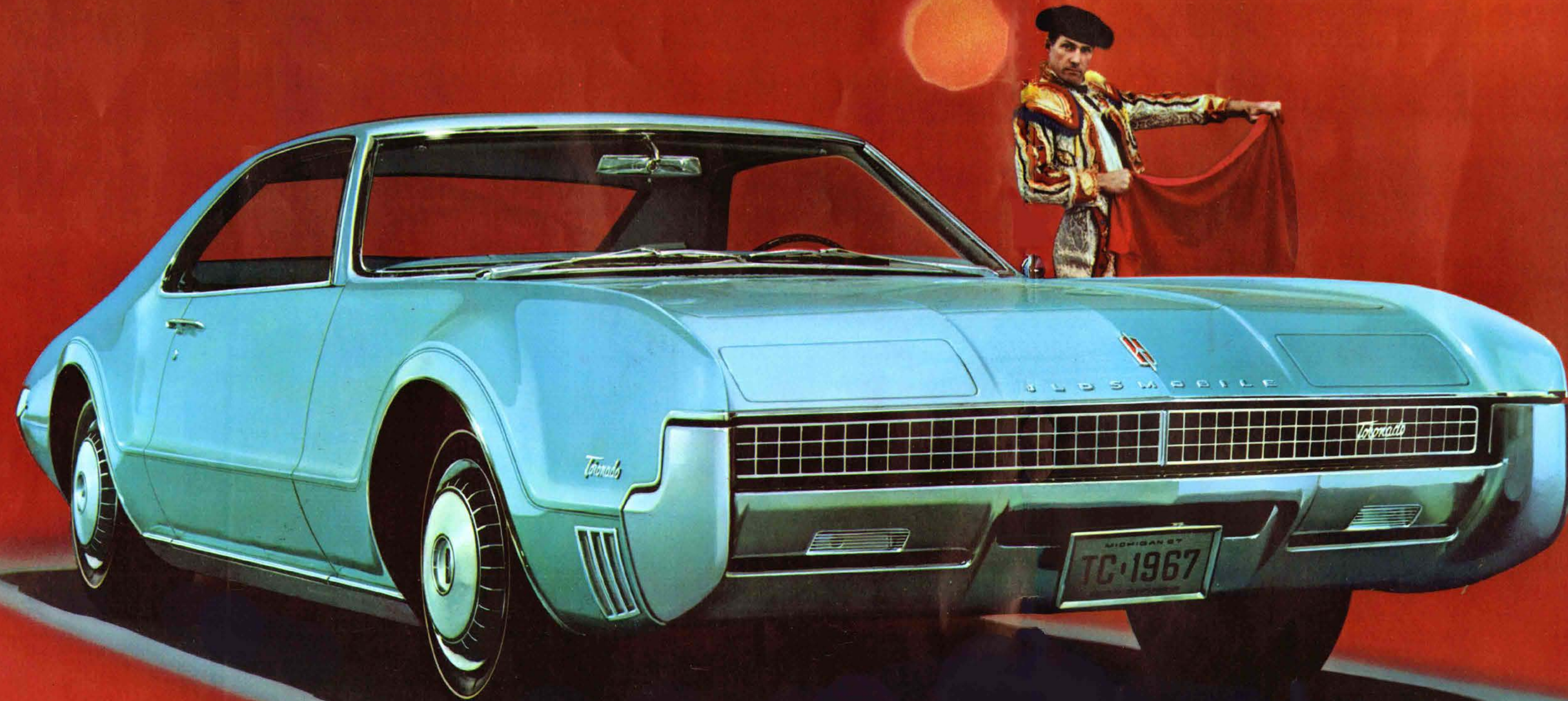

TORONADO DELUXE

## TORONADO

Imitated. Emulated. Borrowed from.  
But nothing really tops the  
genuine article. Back with a flair.  
Better than ever.

*After all the pomp and ceremony of its first year, Toronado has quite a reputation to uphold. But the Oldsmobile designers who effected the transformation of the Toronado did so with obvious success. For while Toronado, '67 edition, retains all the virtues of its first-year forerunner, it's as remarkably new as a classic dares to be: Bold new front grille. New flush, concealed headlamp design. New wheel decor. New interior elegance. New ride refinements. New easier-opening doors. New safety features. All deftly dovetailed with the flat-floored, room-for-six comfort, the superior handling and the remarkable roadability that have already marked front-wheel-drive Toronado as a breed apart. Imitated? Of course. Emulated? Indeed. Borrowed from? To be sure. But Toronado remains the first, the genuine, the original—dramatically revisited for 1967. Turn the page, please, for specifics of America's first full-size front-wheel-drive car.*

Olds offers, at modest extra cost, a variety of options and accessories, many of which are shown in the car illustrations and described on pages 40, 41 and 46.

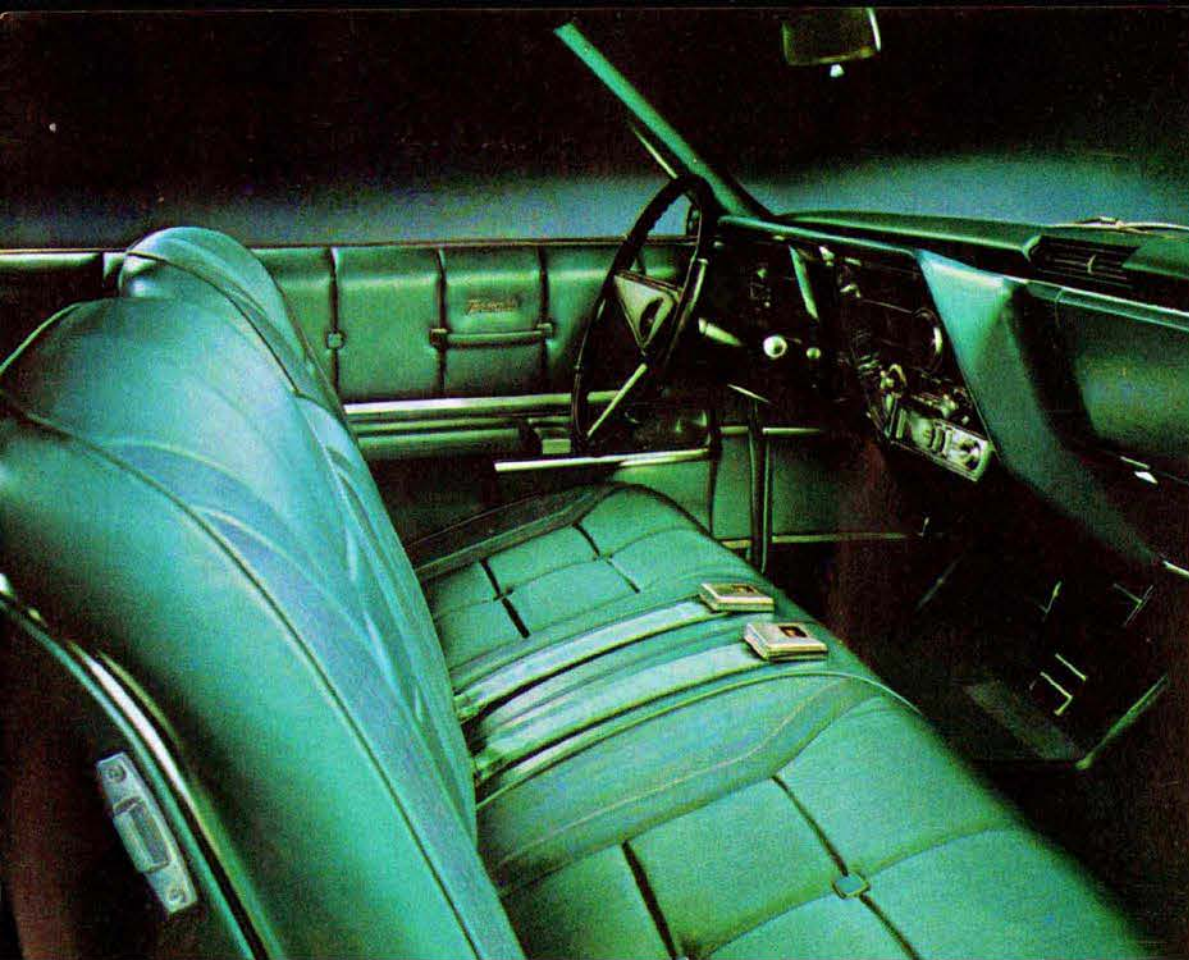

Toronado thinks of everything in the inside-ease department! **A** Example: That lavishly foam-padded Strato Seat—complete with fold-down armrest—standard on the Deluxe model. Example: Toronado's ride—now softer and quieter, compliments of new body mounts, new lower spring rates, new shock absorbers (two front, four rear). Example: Toronado's easy-does-it handling, direct result of its thoroughly-proved front-wheel drive. High-style fabrics door to door, deep-pile carpeting sill to sill, make Toronado's interior look like the lap of luxury, too (which, of course, it is!) **C** Distinctive Toronado fastback (below) tapers to a new taillight design, counterpart of the bold new grille. Chic vinyl top in black or champagne is available on either of the two Toronado coupes. Outside rearview mirror, backup lights are only a pair of the many standard safety items on all '67 Oldsmobiles.

Olds offers, at modest extra cost, a variety of options and accessories, many of which are shown in the car illustrations and described on pages 40, 41 and 46.



## TORONADO

The only car that outdoes first-year Toronado for features: second-year Toronado.

**A** If you're the type who thinks buckets are basic, Toronado doesn't argue. Moroccan-tailored Strato Bucket Seats are available on Deluxe models, no charge. **B** Transmission bulge and drive-line hump are out in front-wheel-drive Toronado. Flat floors, front and back, are very in. **C** Toronado instrument panel is generously padded, designed for driver convenience. AM-FM Radio, AM-FM Stereo Radio and Stereo Tape Player are all available. **D** Distinctive wheel covers, subtle accent stripe, cornering lights are Toronado touches available on both models. Back of those handsome hubs are husky finned brakes, now even more efficient. **E** Draft-free ventilation system brings air in at five inlets, circulates it through car and out rear louvers. Eliminates vent windows, assures quiet ventilation, summer or winter.

**TORONADO SPECIFICATIONS:** Wheelbase, 119"; overall length, 211"; overall width, 78.5"; overall height, 52.8"; tire size, 8.85 x 15". **STANDARD EQUIPMENT:** 385-hp Toronado Rocket V-8; Turbo Hydra-Matic Drive; power steering and brakes; lighter; clock; carpeting; heater-defroster; parking brake signal lamp; deluxe steering wheel; full complement of Oldsmobile safety features (pages 3 and 43).



### TORONADO FRONT WHEEL DRIVE: A STUDY IN PERFORMANCE... BY DESIGN!

- 1** Toronado Rocket V-8 is 425 cubic inches big. Features improved Quadrajet Carburetor for dependable performance, maximum economy. Delivers 385 horsepower, 480 lb.-ft. torque with 10.5-to-1 compression. May be equipped with Climatic Combustion Control—an Oldsmobile innovation that regulates carburetor temperature, reduces warm-up time and eliminates winter icing.
- 2** Turbo Hydra-Matic Drive, designed expressly for Toronado, provides 180° forward power transfer, features variable-vane torque converter for smooth Rocket Action at all speeds.
- 3** Planetary differential—low-friction Olds design—transfers power through 3.21-to-1 gear ratio.
- 4** New front drive shafts feature twin constant-velocity universal joints for smooth flow of Rocket V-8 power.
- 5** Massive Toronado wheels pull (not push) you through turns, snow, rugged terrain. 8.85 x 15-inch tires take a big bite for surer traction.
- 6** Unique rear suspension features leaf spring, four rear shock absorbers for excellent roadability.
- 7** Energy-absorbing steering column is a standard safety feature on all '67 Oldsmobiles.

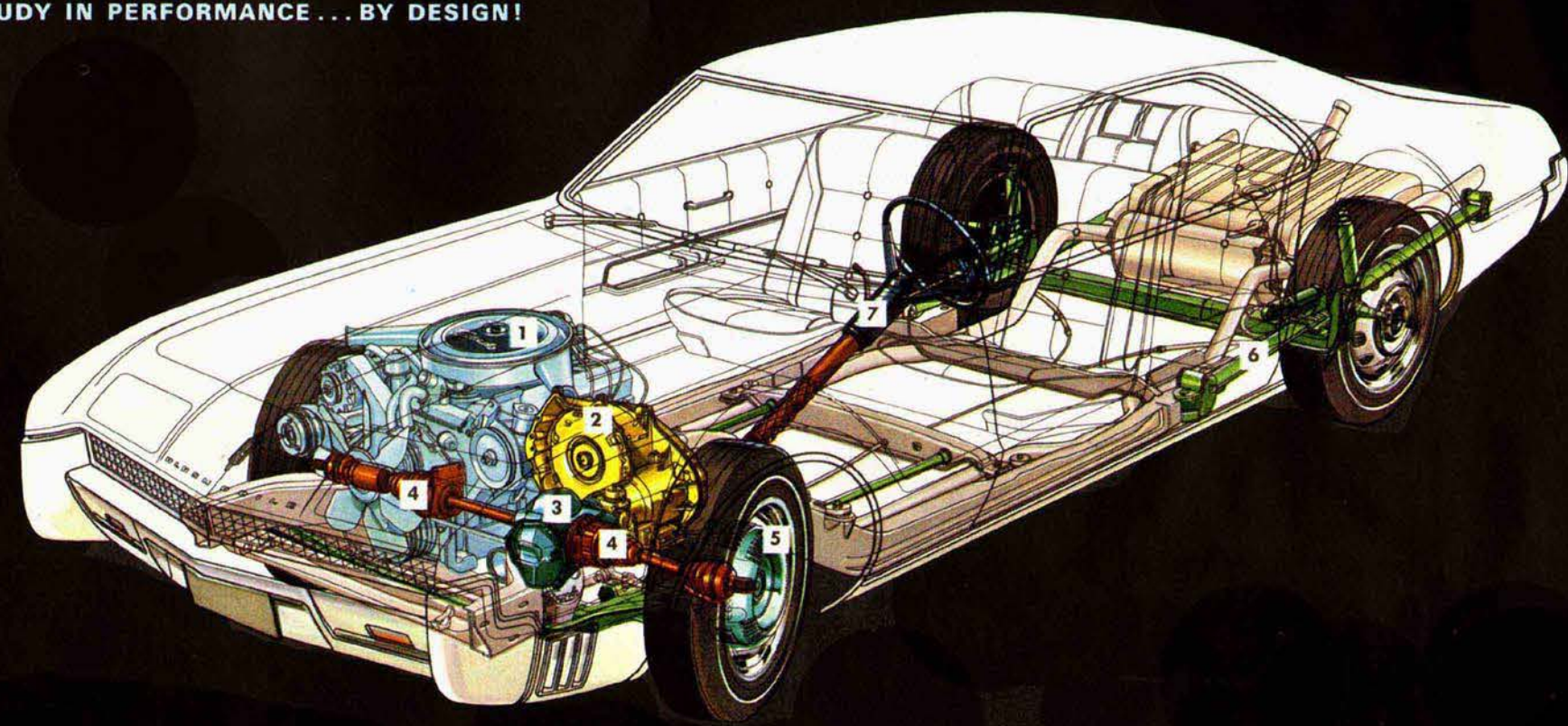

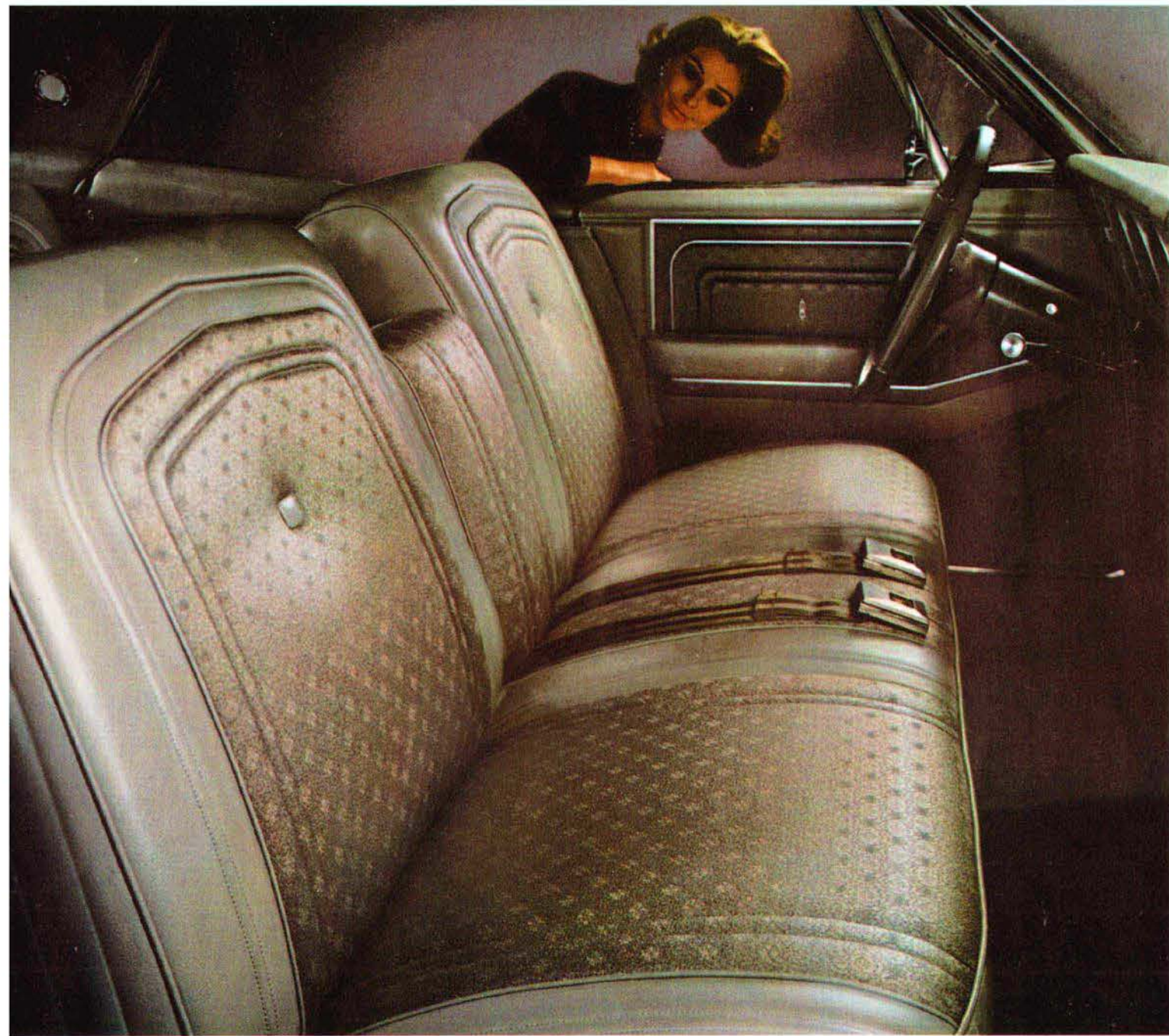

## NINETY-EIGHT



It's a very good year.

*If you've ever felt the quiet compulsion to go absolutely elegant, please consider 1967. And the new quality-built Oldsmobile Ninety-Eight.*

*Here is an automobile minted for the proud. For those who would appreciate the dramatics of an interior like the Holiday Sedan version, shown left. Subtle brocades. Deep-pile carpeting, including the kick panels. Fold-down front armrest, of course.*

*And colors that make the spectrum seem suddenly incomplete. Calling your attention to Ninety-Eight's striking new form is a bit like pointing out the Eiffel Tower. You could hardly miss it. New front. New side. New roofline. New rear. Luxury personified in every detail. Magnificent new Ninety-Eight for 1967. A very good year indeed.*

Olds offers, at modest extra cost, a variety of options and accessories, many of which are shown in the car illustrations and described on pages 40, 41 and 46.



NINETY-EIGHT HOLIDAY SEDAN



## NINETY-EIGHT

What a wonderful place to spend 1967!



NINETY-EIGHT LUXURY SEDAN

*There are those to whom the finest is strictly a way of life. To whom treasured fabrics, meticulously-crafted embroidery, impeccably-tailored carpets are as indispensable as a chic coiffure or a suit that fits. And for those, Oldsmobile offers the 1967 Luxury Sedan.*

☐ *The LS provides a choice of six interiors—plus, at modest extra cost, this special jet-black Royale design. Such amenities as recessed vanity and assist handles, special front-and-rear door pulls and folding armrests are, of course, included.* ☐ *Outside, both Luxury and Town Sedan show subtle Toronado influences. Fashionably flared wheel openings. Rear deck, five inches shorter. Hood, five inches longer. And beneath it, a 425-cubic-inch Super Rocket V-8 quietly powers your Ninety-Eight with an ease befitting its elegance.* ☐ *Incidentally, every Ninety-Eight features Oldsmobile's '67-improved four-coil-spring ride, complemented by an efficient dual-brake system and finned front drums.*

Olds offers, at modest extra cost, a variety of options and accessories, many of which are shown in the car illustrations and described on pages 40, 41 and 46.



NINETY-EIGHT TOWN SEDAN

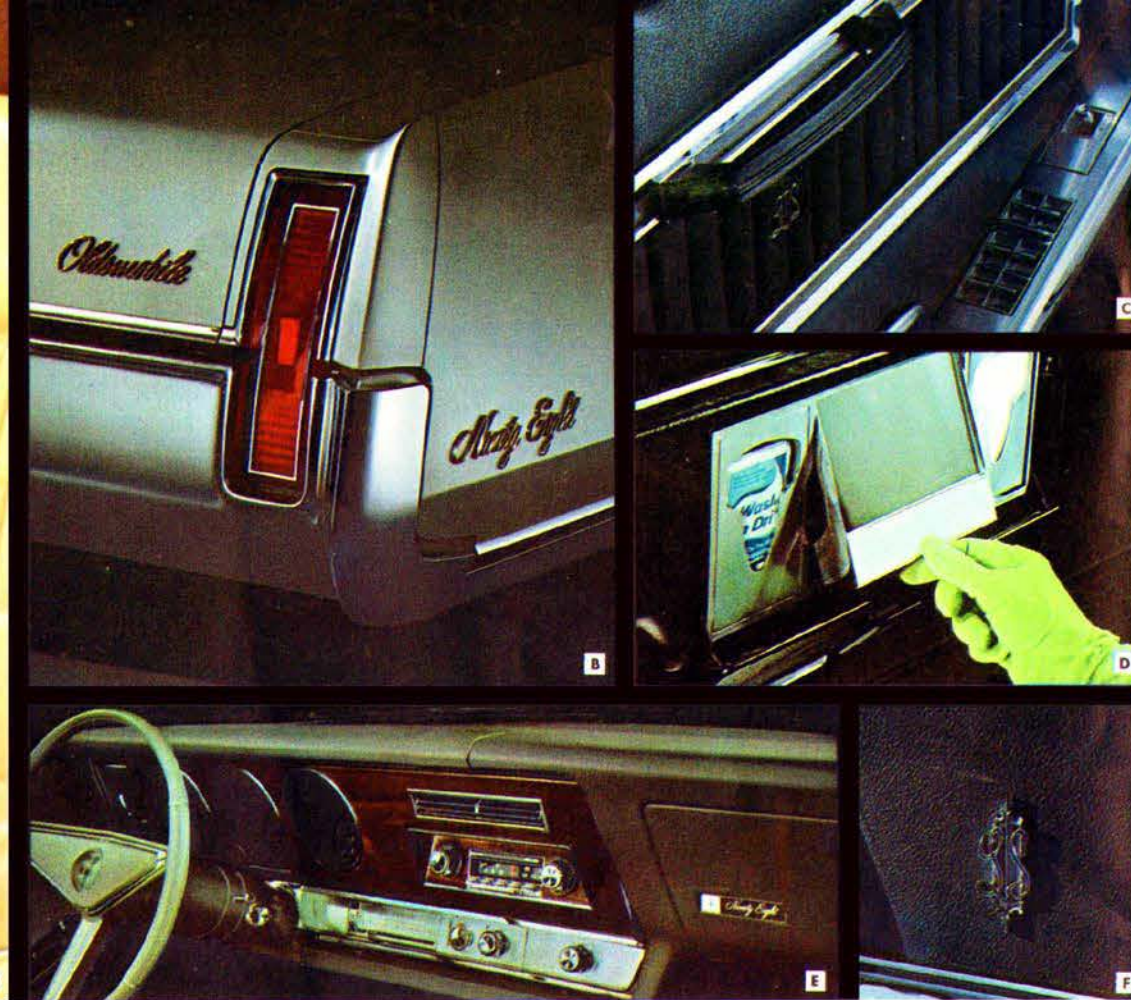

**A** This is the kind of Convertible interior that almost makes you want to buzz the top down in any weather! If sunshiny yellow's a favorite, you can get the rest of the car to match. Or choose from other stylish inside colors. Cushion-contoured front Strato Seat with folding armrest is standard on Ninety-Eight Convertible.

**B** Detailing has always been an Olds strong point. Ninety-Eight's new integrated vertical taillight is a case in point. Brawny bumper is triple-chromed, by the way.

**C** Luxury Sedan combines fashion and function in this smart power control console at driver's fingertips.

**D** Rear-seat LS vanity features convenient tissue dispenser, towelette dispenser, mirror. Closes flat to seat back. **E** Walnut-grain vinyl paneling adds a rich touch to Ninety-Eight's adroitly clustered instrument panel. **F** Fashionable vinyl roof is available, in black or champagne, on all Ninety-Eight closed models.

**NINETY-EIGHT SPECIFICATIONS:** Wheelbase, 126"; overall length, 223"; overall width, 80"; overall height (Town Sedan), 55.8"; tire size, 8.85 x 14". **STANDARD EQUIPMENT:** 365-hp Super Rocket V-8; Turbo Hydra-Matic Drive; power steering; power brakes; power windows and two-way power seat (except Town Sedan); deluxe steering wheel; parking brake lamp; glove box and courtesy lamps; carpeting; clock; wheel discs; heater-defroster; full complement of Oldsmobile safety features (pages 3 and 43).

Olds offers, at modest extra cost, a variety of options and accessories, many of which are shown in the car illustrations and described on pages 40, 41 and 46.



NINETY-EIGHT CONVERTIBLE



## NINETY-EIGHT

Fine-car quality and features without paying the fine-car price.



NINETY-EIGHT HOLIDAY COUPE



DELTA 88 CUSTOM HOLIDAY SEDAN

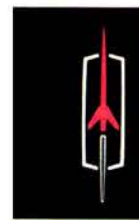

## DELTA 88 CUSTOM

Two all-new Custom hardtops highlight the Delta 88 line. Do they gild the lily?

*Indeed they do! Every line of cars has to have an epitome or two. And for Delta 88, it's a pair of Custom hardtops, all new for '67 and more luxuriously endowed than any 88 ever to precede them. ☛ Gleaming new grille and Toronado-inspired contours brand both Coupe and Sedan as members of the exclusive Delta club. Yet a wide, brushed-stainless side molding, an individualized rear end and singularly elegant appointments distinguish Delta Custom from any other '67 entry, Olds or otherwise. ☛ The honey-hued interior (at right) belongs to the Delta Custom Sedan. It's one of six colors in all-Moroccan or Moroccan-and-fabric (five on the Coupe). Contoured Strato Seat with fold-down front armrest, color-keyed carpeting, brilliant chrome accents all further the luxury cause (And they're all yours at a remarkably conservative Delta Custom price!). So if all that beguiling finery constitutes gilding the lily, well . . . aren't you glad Olds did?*

Olds offers, at modest extra cost, a variety of options and accessories, many of which are shown in the car illustrations and described on pages 40, 41 and 46.





## DELTA 88 CUSTOM



Olds built it in the public interest. (The luxury-loving public, that is.)



DELTA 88 CUSTOM HOLIDAY COUPE

**A** Some cars have living-room comfort. But home was never like this! These shapely Moroccan-tufted Strato Bucket Seats are standard on the Coupe (bench seat, available, no charge). Sumptuous as it is, the Delta 88 Custom Coupe (like all Oldsmobiles) is chock-full of standard safety features: Folding-front-seat-back latches, front and rear seat belts, energy-absorbing steering column, outside rearview mirror and padded instrument panel are a few you can count from here. **B** Console is standard on Coupe, too. You can equip it with Turbo Hydra-Matic, as shown, perfect counterpart to Delta's 425-cubic-inch Super Rocket V-8. Walnut-grained shift grip and instrument panel add a tasteful touch. **C** Stow it and go! Big trunk handily holds 17.1 cubic feet of gear. **D** The Toronado treatment complements Delta Custom's smart new rear motif. Backup lights are standard on all Olds models. **E** Bold, bracketed headlamp design distinguishes all Delta 88s. **F** Smart nameplate, wide louvered side molding identify Delta Custom with a flair.

**DELTA 88 CUSTOM SPECIFICATIONS:** Wheel-base, 123"; overall length, 217"; overall width, 80"; overall height (Sedan), 54.5"; tire size, 8.55 x 14".  
**STANDARD EQUIPMENT:** 300-hp regular-gas Super Rocket V-8 (310-hp premium-gas Super Rocket V-8, when Turbo Hydra-Matic is specified); clock; carpeting; console, bucket seats on Coupe; Strato Bench Seat on Sedan; heater-defroster; parking brake signal lamp; glove box and courtesy lamps; deluxe steering wheel; wheel discs; full complement of Oldsmobile safety features (pages 3 and 43).

Olds offers, at modest extra cost, a variety of options and accessories, many of which are shown in the car illustrations and described on pages 40, 41 and 46.

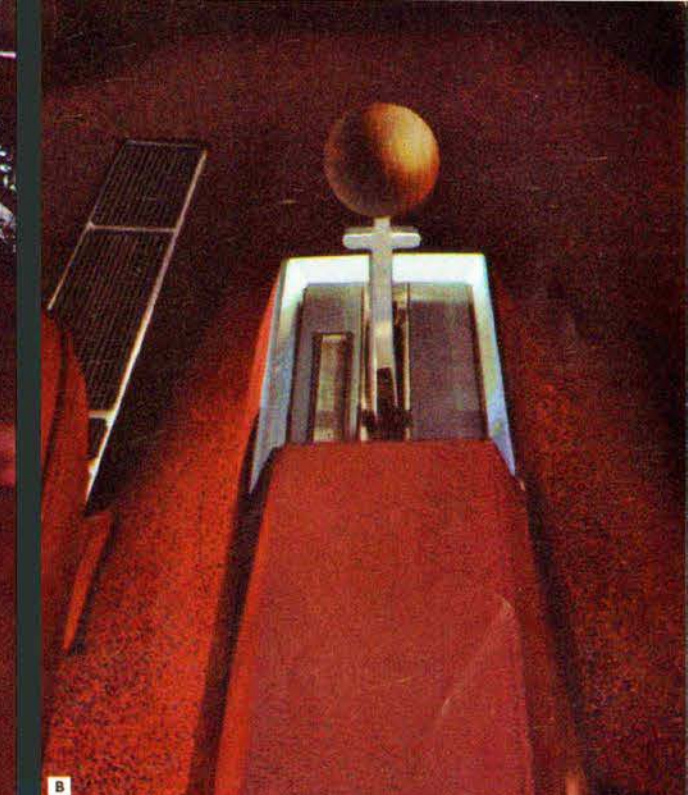



## DELTA 88



Some people may think your new Delta looks like a Toronado. So be it.

*Toronado's one-of-a-kind look has obviously started a trend. But that bothers us not a bit. Fact is, Olds has borrowed from Olds more than anybody has. ☛ Example: The smart new Toronado-inspired Delta 88. Longer hood (by a full five inches), shorter rear deck, sleekly tapered fastback, flared wheel openings are obvious Toronado nuances in all four Delta 88 models. ☛ Yet Delta has a full catalog of its own virtues, too. Performance, tailored to your taste, product of a 425-cubic-inch Super Rocket V-8, premium- or regular-fuel type. Softer Delta ride, thanks to new coil springs, new shock absorbers, new body mounts. Extra measure of silence, compliments of quieter drive components. Dual braking system with fluid-level warning light.*

*☛ Inside, Delta 88 has elegance to spare. Spacious Custom Sport Seat (shown at left) is standard on Holiday models and Convertible. Carpeting extends up door panel to become as decorative as it is practical. And you've a choice of six interior colors on the Coupe, seven on the Holiday Sedan, six on the Town Sedan and five on the Convertible.*

Olds offers, at modest extra cost, a variety of options and accessories, many of which are shown in the car illustrations and described on pages 40, 41 and 46.



DELTA 88 HOLIDAY COUPE

**A** Svelte is the word for Delta's clean, uncluttered rear sculpturing, its highly individualistic taillight design. Backup lights, flanking the license plate, are standard, of course. **B** The cushy life is built right in! Front armrest is a feature of the Custom Sport Seat, standard on Holiday models and Convertible. Fold it down, you have the cozy comfort of bucket seats. Fold it up, you enjoy the three-passenger comfort of a bench model. **C** This may be the cleanest sweep in the country! Flared wheel openings display the Toronado touch. Smart new wheel discs are available to distinguish your new Delta 88. **D** It's pretty hard to top a Delta 88, but here's one stylish way: Specify this fashionable vinyl top, available in black or champagne on all Delta 88 closed models.

**DELTA 88 SPECIFICATIONS:** Wheelbase, 123"; overall length, 217"; overall width, 80"; overall height (Town Sedan), 55.5"; tire size, 8.55 x 14". **STANDARD EQUIPMENT:** 300-hp regular-gas Super Rocket V-8 (310-hp premium-gas Super Rocket V-8, when Turbo Hydra-Matic is specified); carpeting; heater-defroster; parking brake signal lamp; glove box and courtesy lamps; deluxe steering wheel; wheel discs; full complement of Oldsmobile safety features (pages 3 and 43). Olds offers, at modest extra cost, a variety of options and accessories, many of which are shown in the car illustrations and described on pages 40, 41 and 46.



DELTA 88 HOLIDAY SEDAN



DELTA 88 CONVERTIBLE

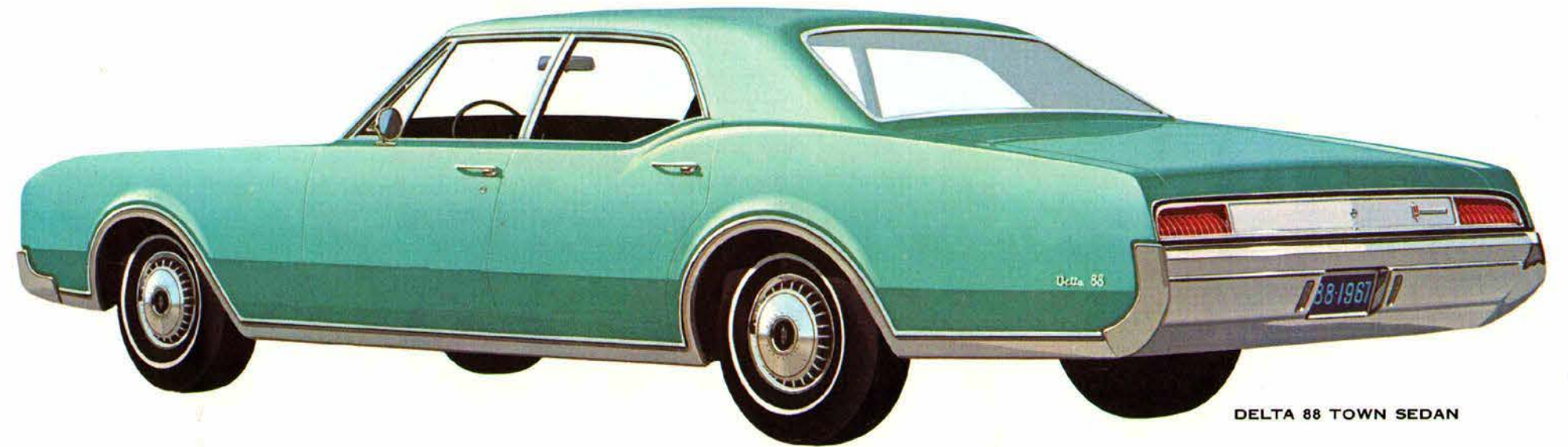

DELTA 88 TOWN SEDAN



**DELTA 88**

Beautiful difference between stale and style!



DELMONT 88 HOLIDAY SEDAN



## DELMONT 88

Brand-new 88 series!  
Goes to show what Olds can do  
with a modest price tag . . .  
and a lot of Toronado inspiration.

*Being first in your block never seemed more pertinent than it does now. And Oldsmobile's entirely new Rocket series, Delmont 88, is why. Fact is, owning a Delmont 88 — with its own impressive grille, its own side treatment, its own rear styling and its own glamorous interior — is a point of distinction, whether you're first or fifteenth!* ◀ *The Delmont 88 makes its debut in four bold body styles: Holiday Sedan (shown left), Holiday Coupe, Town Sedan, Convertible. Available in two versions: 425-cubic-inch Super Rocket V-8 or 330-cubic-inch Jetfire Rocket V-8. Both yours to specify in either regular or premium fuel. (Exception: Convertible is offered with larger engine only.)*

◀ *Hardtop interior (at right) takes a back seat to none! And there are five more where that came from! Fashionable fabrics, rich Moroccan, gem-like appointments and plush carpeting all combine to do the honors. ◀ Perhaps it seems crass to mention price in the face of all this glamour. But a dollar being a dollar these days, consider this: For all its quality, all its luxury, Delmont 88 is Oldsmobile's lowest-priced full-size series, actually priced lower than many models with low-price names!*

Olds offers, at modest extra cost, a variety of options and accessories, many of which are shown in the car illustrations and described on pages 40, 41 and 46.

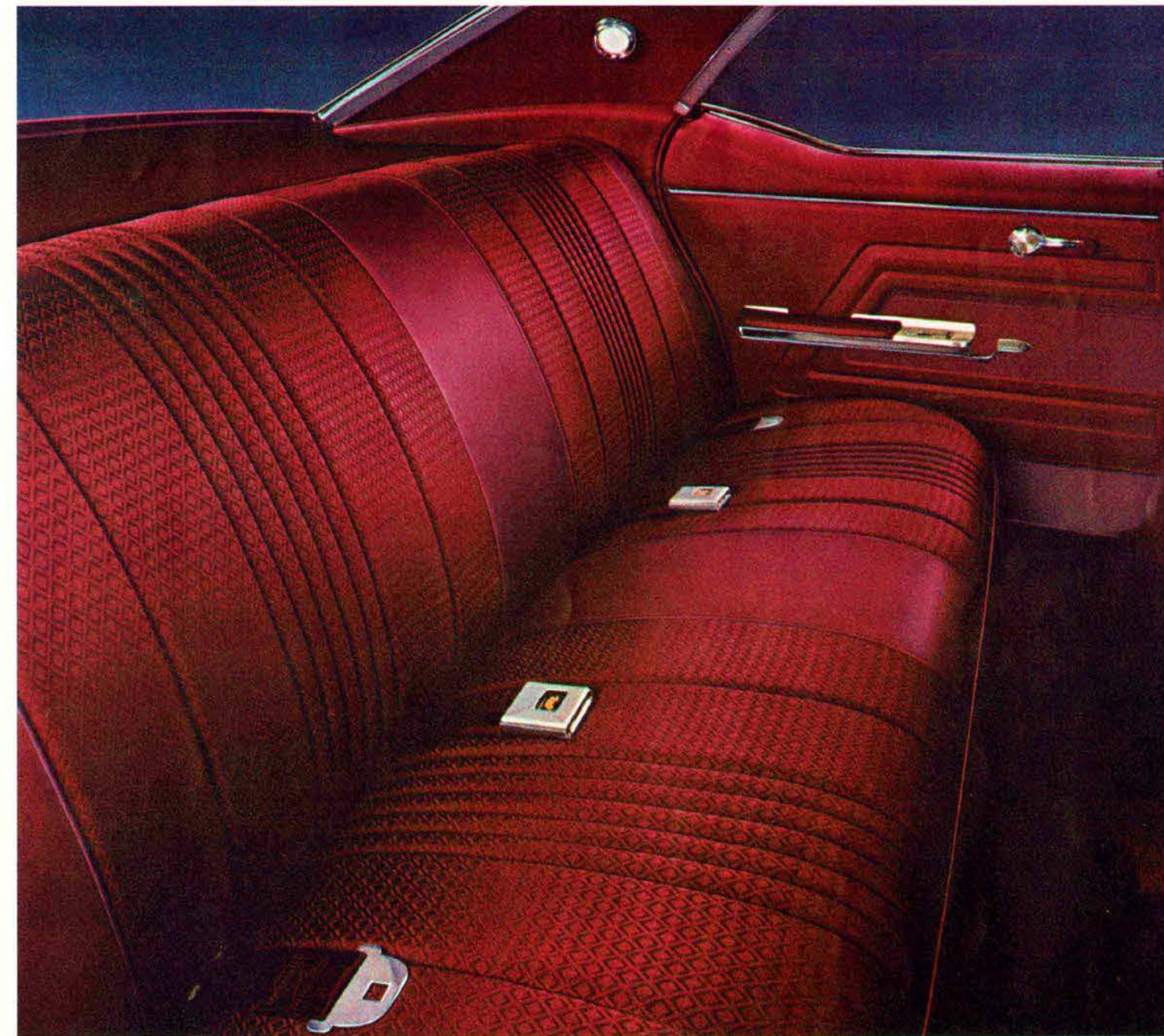



DELMONT 88 TOWN SEDAN



## DELMONT 88

**Axiomatic:** When Oldsmobile designs a new series, it does so with a flourish!

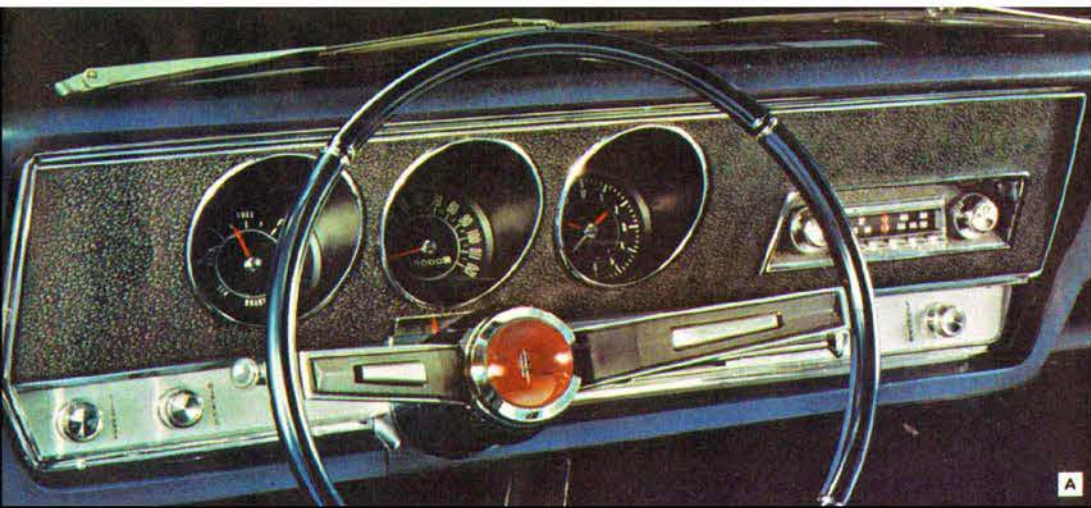

A



B



C

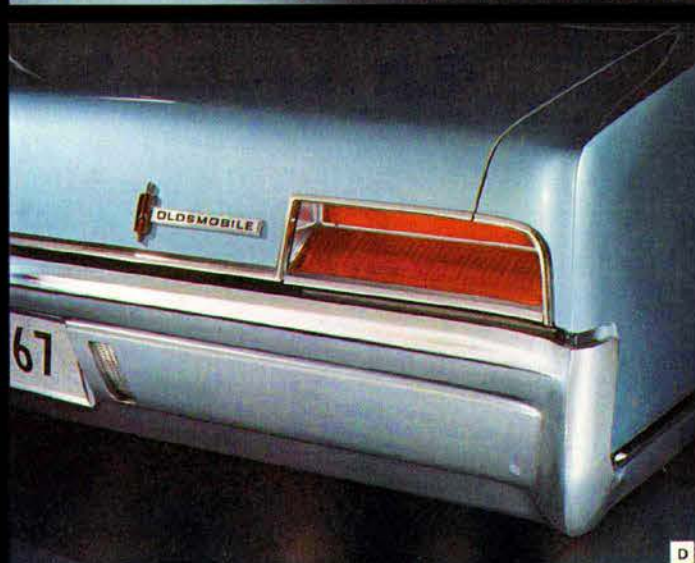

D

**A** Delmont 88 instrument panel deftly combines convenience, safety and style. Handsome grained-vinyl panel is fully padded. Recessed dials reduce glare, as does satin finish on chrome detailing. Soft, low-profile window control knobs are color-keyed. And, as on all Olds models, steering column is energy-absorbing. **B** Smart Delmont 88 nameplate, tasteful molding and Toronado-inspired wheel cutouts distinguish Oldsmobile's newest 88 from all comers. **C** Full-fledged member of the Olds clan, but an individualist all the way. Delmont 88's fashionable face makes the point admirably. And back of it—a smooth four-coil spring, 123-inch-wheelbase ride. **D** Delmont 88's rear end is equally sleek. Horizontal taillight tops gleaming triple-chromed bumper.

**DELMONT 88 SPECIFICATIONS:** Wheelbase, 123"; overall length, 217"; overall width, 80"; overall height (Town Sedan), 55.5"; tire size, 8.55 x 14". **STANDARD EQUIPMENT:** 310-hp or 300-hp Super Rocket V-8; or 260-hp or 250-hp Jetfire Rocket V-8; carpeting; heater-defroster; parking brake signal lamp; wheel discs; full complement of safety features (pages 3 and 43).

Olds offers, at modest extra cost, a variety of options and accessories, many of which are shown in the car illustrations and described on pages 40, 41 and 46.



DELMONT 88 HOLIDAY COUPE



DELMONT 88 CONVERTIBLE

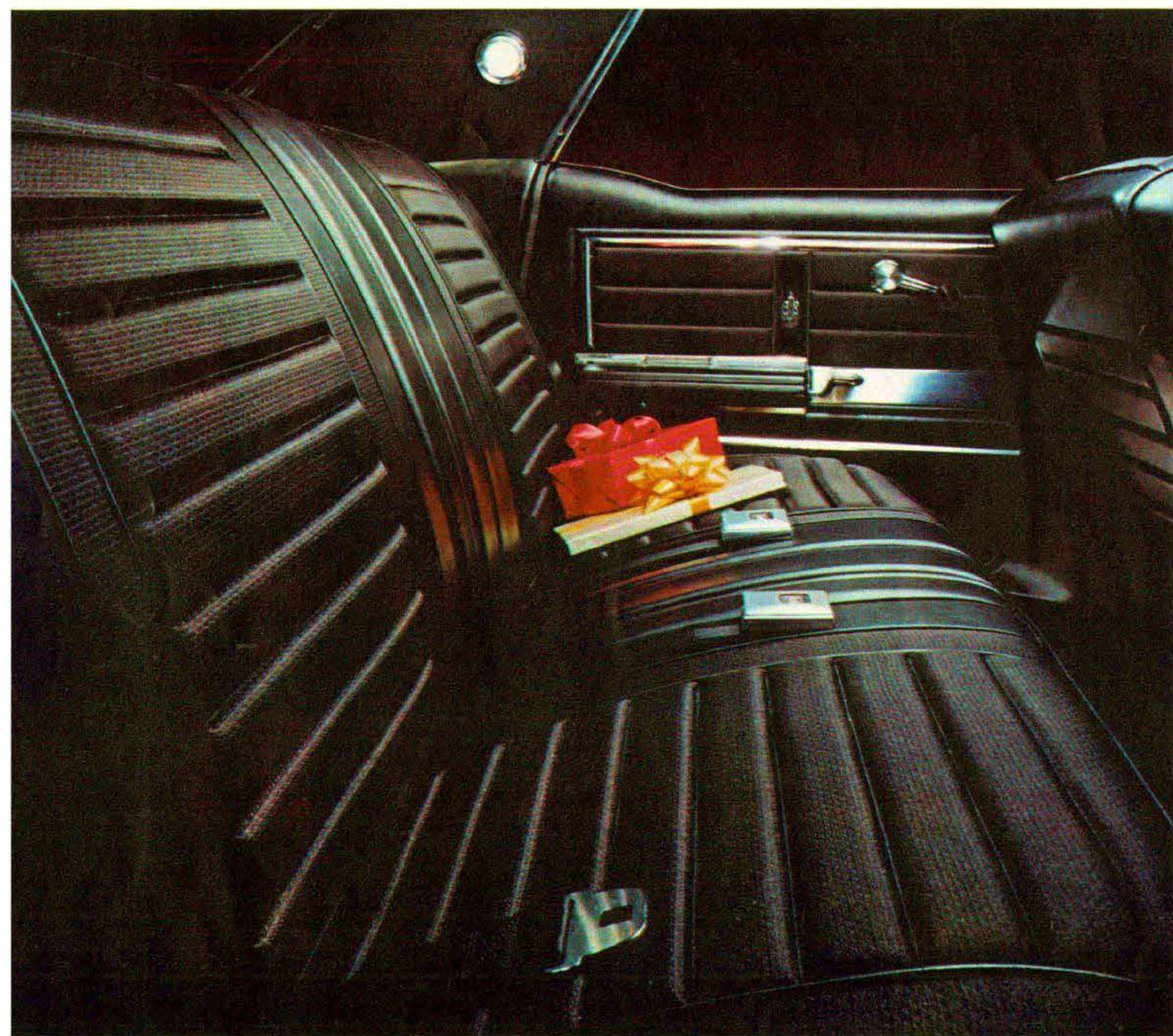

## CUTLASS SUPREME



All was quiet in the low-price field.  
Then Olds unleashed  
a whole new five-car series.

*Leave it to Olds to take one vastly-luxurious, modestly-priced model and parlay it into a whole breathtakingly new series. That's the story of Cutlass Supreme—five magnificent new entries, smack in the low-price field! ❏ Fancy yourself, for instance, in this debonair new four-door. That cloth-and-Moroccan interior (one of five) has all the black-tie elegance of a night at the Met. ❏ Yet the Cutlass Supreme is as lively as it is luxurious. A 330-cubic-inch Jetfire Rocket V-8 is yours in either premium- or regular-fuel versions. And both are available with Oldsmobile's newest engineering breakthrough:*

*Climatic Combustion Control to govern carburetor air temperature, boost economy, reduce warm-up time and eliminate winter icing. Special Turnpike Cruising Package also available on 2-door models to provide top economy at highway speeds. Includes a 400-cube Rocket V-8 with 2-barrel carb; heavy-duty front and rear suspension; 2.41-to-1 expressway rear axle. ❏ Moral: When you visit the low-price field, visit Cutlass Supreme—finest of the F-85s. But first, visit the next page for a preview of the other four.*

Olds offers, at modest extra cost, a variety of options and accessories, many of which are shown in the car illustrations and described on pages 40, 41 and 46.



CUTLASS SUPREME HOLIDAY SEDAN



CUTLASS SUPREME HOLIDAY COUPE



CUTLASS SUPREME CONVERTIBLE

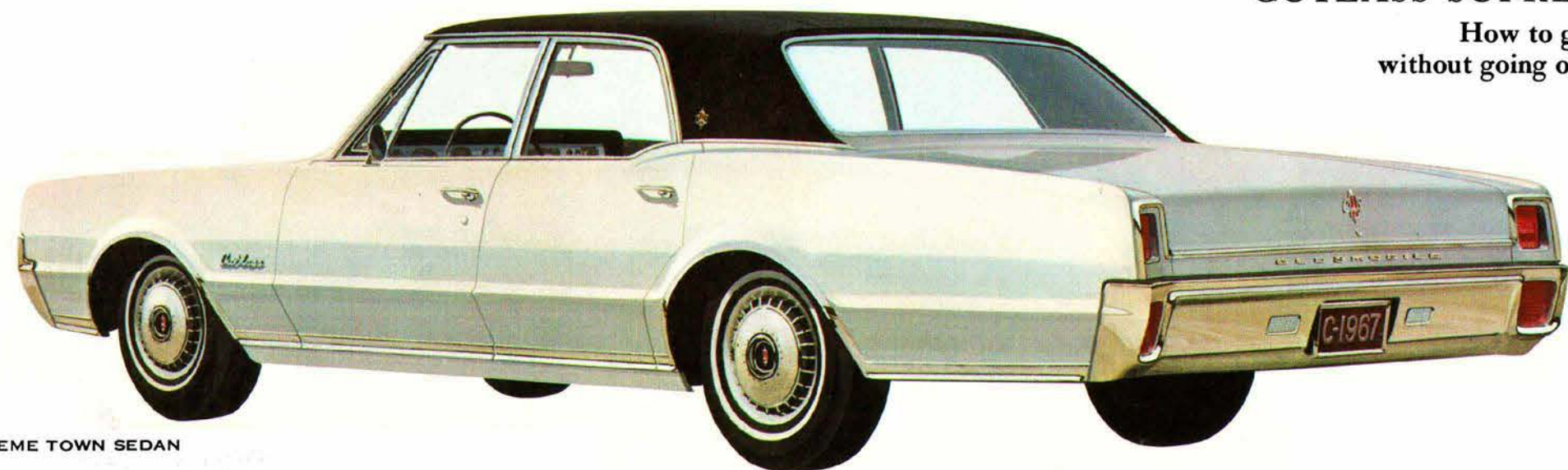

CUTLASS SUPREME TOWN SEDAN

## CUTLASS SUPREME

How to go elegant  
without going overboard.



*Cutlass Supreme has a simple purpose in life: To let you live big and spend small simultaneously. ▣ And this sumptuous, sunny-side-up Convertible interior is one gay example.*

*Thin-shell Strato Bucket Seats are standard in four colors, though bench model is yours for the asking. You can equip the bucket version with console—control center for Jetaway Drive or four-speed stick availabilities. ▣ Crisp molding sets off the Toronado-flared wheel openings. Handsome wheel discs, vinyl top in black or champagne may be specified at extra cost. ▣ Olds obviously cares for your comfort—and your safety. Padded instrument panel and sun visors, inside day-night mirror, energy-absorbing steering column are a few of the standard safety features.*

*▣ This distinctive rear decor is private property of the Cutlass Supreme.*

**CUTLASS SUPREME SPECIFICATIONS:** Wheelbase, 115"; overall length, 204.2"; overall width, 76.0"; height (Town Sedan), 54.4"; tire size, 7.75 x 14". **STANDARD EQUIPMENT:** 320-hp Jetfire Rocket V-8; carpeting; Custom Sport Seat, Holiday Sedan; Strato Bucket Seats on Convertible, Holiday Coupe, Sports Coupe; bench seat, Town Sedan; heater-defroster; deluxe steering wheel; full complement of Olds safety features (pages 3 and 43).

*Olds offers, at modest extra cost, a variety of options and accessories, many of which are shown in the car illustrations and described on pages 40, 41 and 46.*

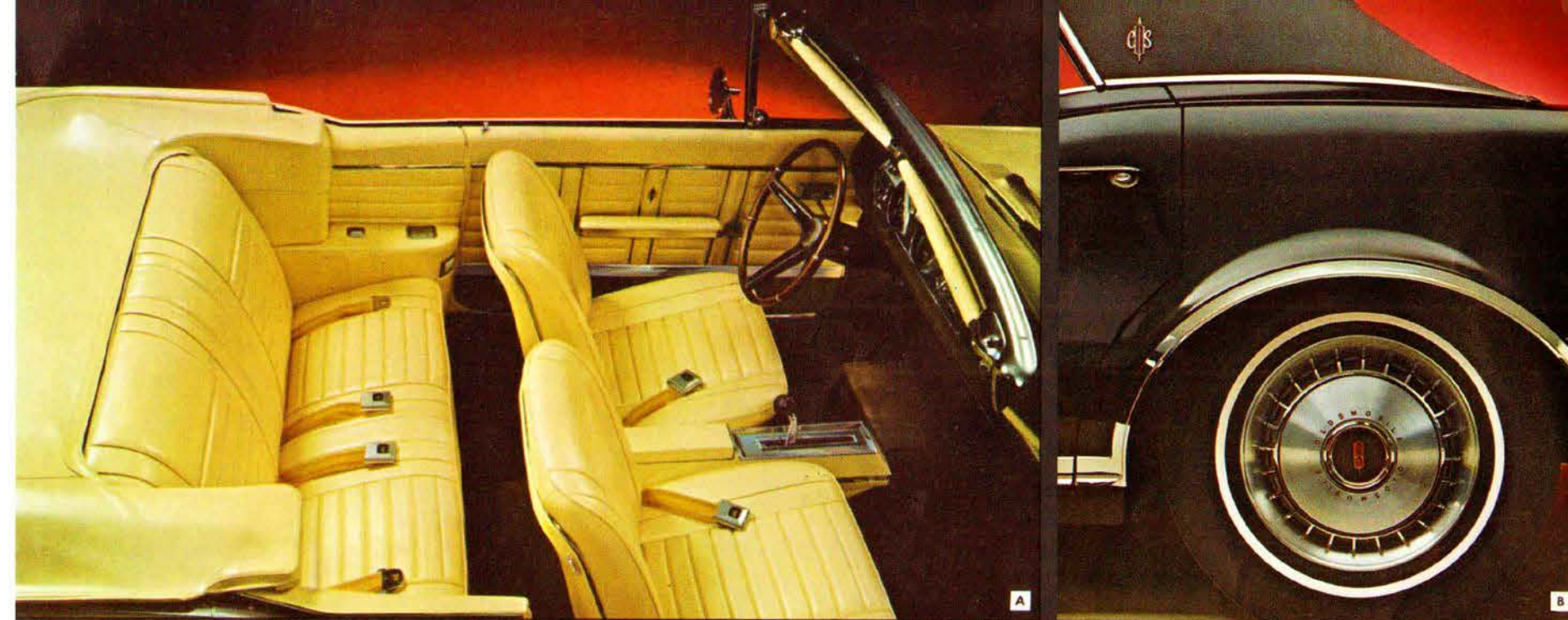

CUTLASS SUPREME SPORTS COUPE

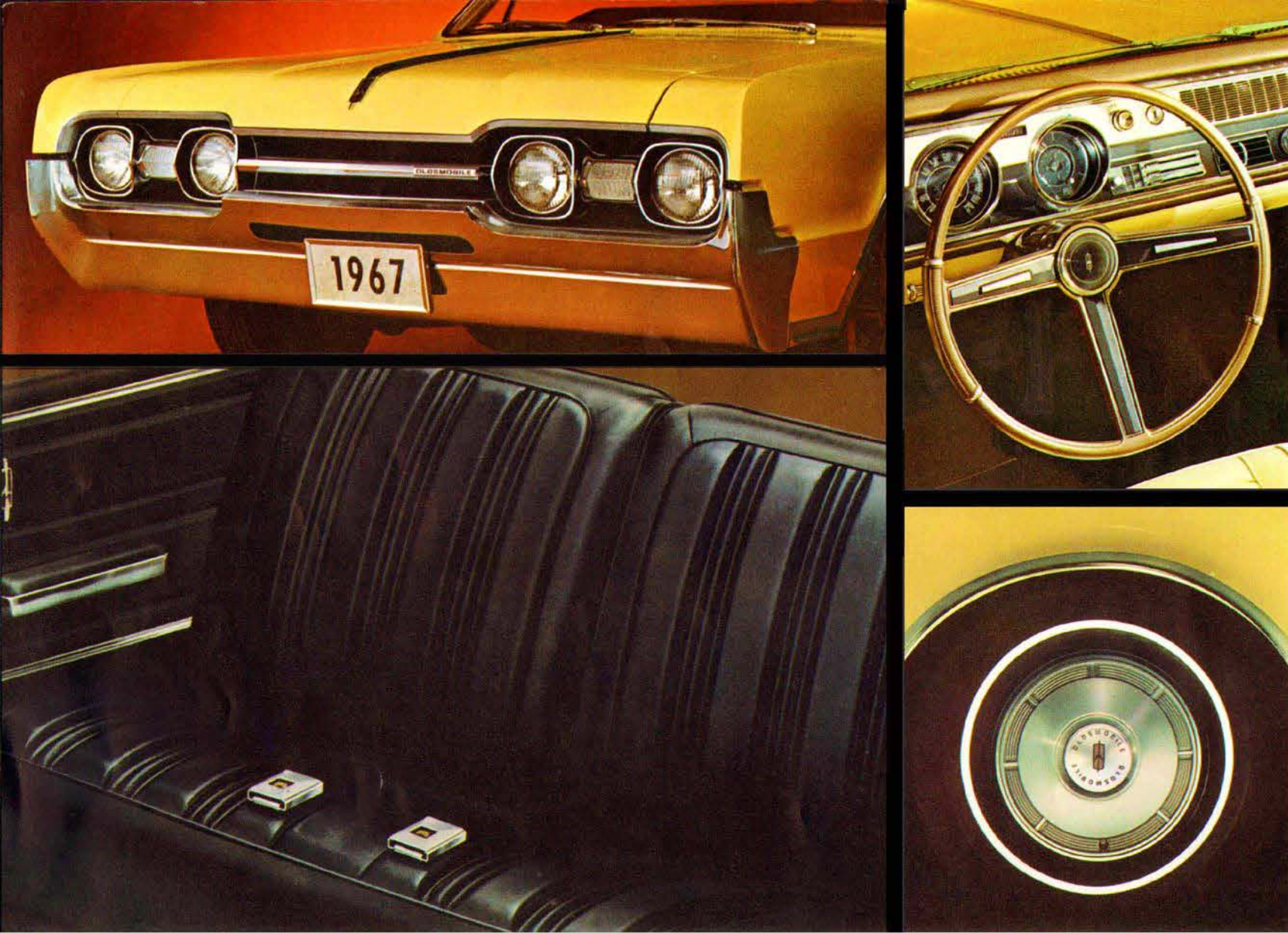

*Houselights down. Curtain up. Cutlass takes the stage with a whole new quartet of pizzazzier-than-ever '67 models. ◀ New front, new back, new middle . . . all make style a Cutlass keynote. Practical all-vinyl or vinyl-and-cloth interiors, tailored in five shades for '67, are fully carpeted. ◀ Cutlass minds your budget with either regular-fuel Jetfire Rocket V-8 or tight-fisted Action-Line 6. Or if performance comes first, you can equip it with a 320-hp Jetfire Rocket, Jetaway Drive, even a four-speed stick. No wonder the new Olds Cutlass is the action leader of the low-price field!*

*CUTLASS SPECIFICATIONS: Wheelbase, 115"; overall length, 204.2"; overall width, 76.0"; height (Town Sedan), 54.4"; tire size, 7.75x14". STANDARD EQUIPMENT: Regular-fuel 250-hp Jetfire Rocket V-8 or 155-hp Action-Line 6; carpeting; heater-defroster; full complement of Oldsmobile safety features (pages 3 and 43).*

*Olds offers, at modest extra cost, a variety of options and accessories, many of which are shown in the car illustrations and described on pages 40, 41 and 46.*

## CUTLASS



Step right in.  
A brand-new "four show"  
is about to begin!



CUTLASS HOLIDAY SEDAN



CUTLASS CONVERTIBLE



CUTLASS HOLIDAY COUPE



CUTLASS TOWN SEDAN



## OLDS F-85

What are you trying to do, Olds?  
Please everybody? You bet!

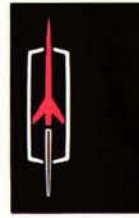

You've already seen how Olds caters to the luxury lover. Now see how beautifully these two lowest-priced Oldsmobiles appeal to the budget-minded. F-85, by name. Money-savers, by nature. **☞** Eye-catching interior, (at right) is shown in one of four stylish colors available. Fashionable rear-window struts are a hallmark of the Club Coupe. Parking brake signal lamp is one of many F-85 extras that doesn't cost extra. And F-85 sports the same array of standard safety features every Olds carries, including a brand-new dual master cylinder brake system. **☞** Both models come equipped with either 250-hp Jetfire Rocket V-8 or 155-hp Action-Line 6, designed for top mileage on regular gas. Both feature the kind of feathery four-coil-spring ride and the kind of engineering excellence that Olds has made famous. And both are priced to make going Olds almost as easy as staying home!

**F-85 SPECIFICATIONS:** Wheelbase, 115"; overall length, 204.2"; overall width, 76.0"; height (Town Sedan), 54.4"; tire size, 7.75 x 14".

Olds offers, at modest extra cost, a variety of options and accessories, many of which are shown in the car illustrations and described on pages 40, 41 and 46.

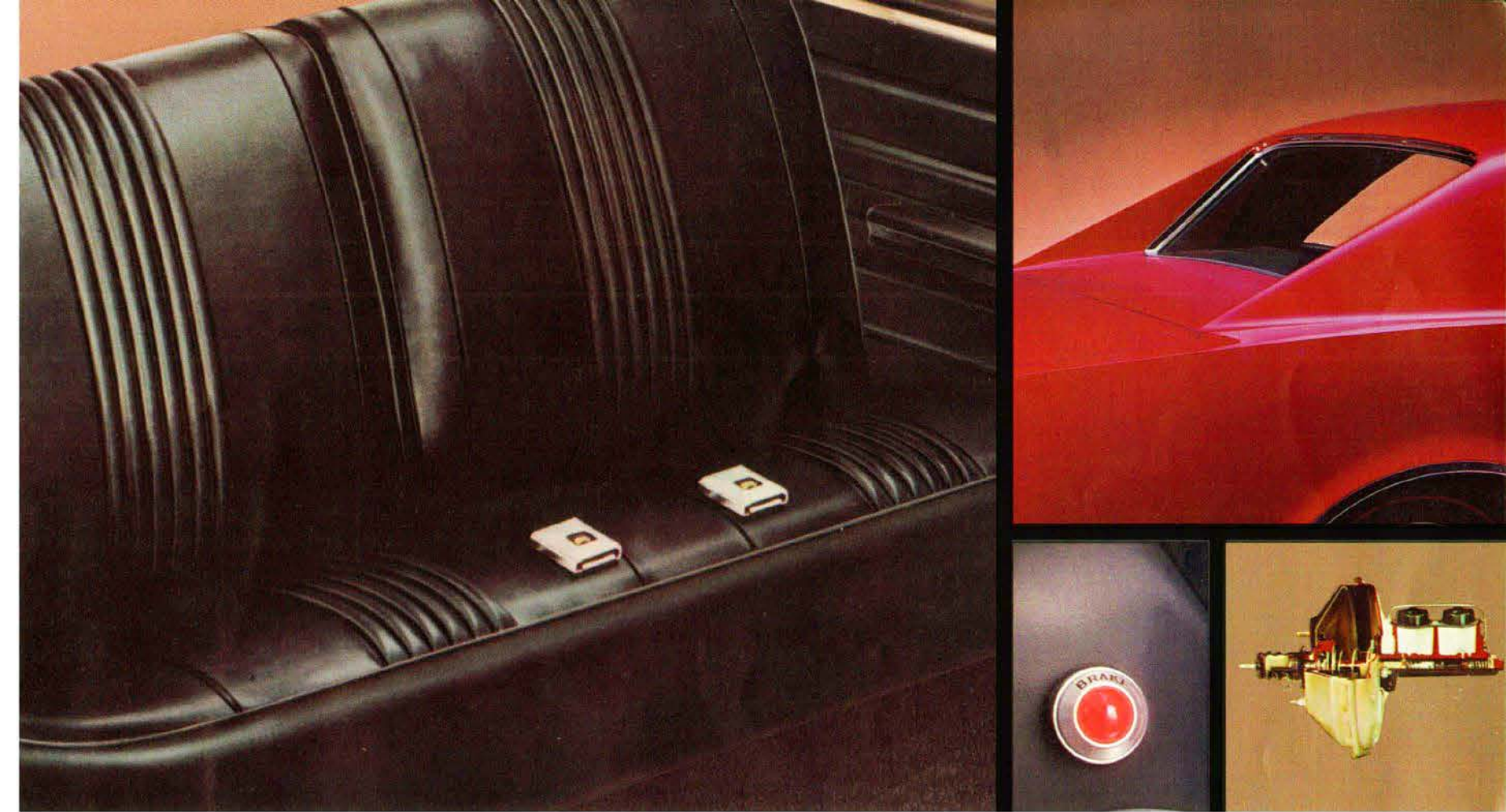

F-85 TOWN SEDAN



F-85 CLUB COUPE



# OLDS 4-4-2

Gay blade. Bon vivant.  
Swashbuckler of the  
Oldsmobile line.



4-4-2 HOLIDAY COUPE

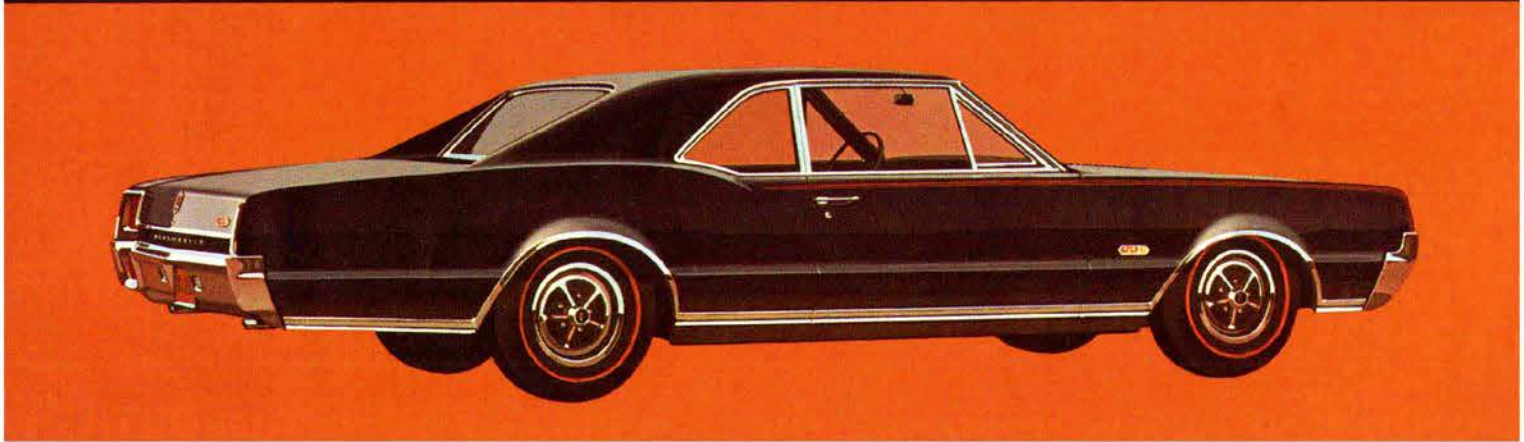
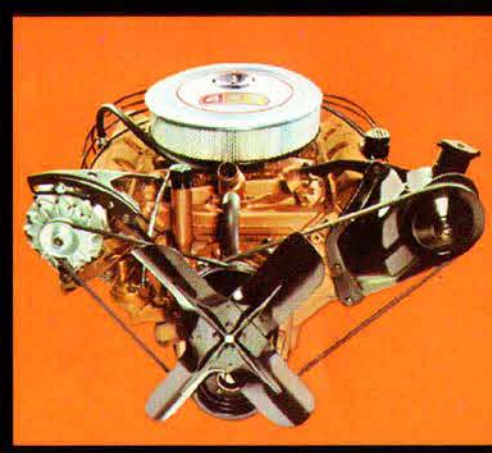

4-4-2 SPORTS COUPE

Every family needs at least one dyed-in-the-wool extrovert. And Olds has three—all called 4-4-2. All genuine-article sports machines, complete in every detail on a generous 115-inch wheelbase. **☞** Swinging front and rear styling, functionally louvered hood, unique side paint-stripe all set 4-4-2 apart in the looks department. Everything else sets it apart in the action area. **☞** 400-cube 4-4-2 Rocket V-8, for instance—a 350-hp, 4-barrel mill, complete with special cam. High-performance axle. Heavy-duty front and rear suspension. Heavy-duty motor mounts. And heavy-duty wheels with Red-Line tires. It's all standard 4-4-2 gear! Inside, buckets are standard (or bench, if you wish). Console (shown left) is also available when you specify Turbo Hydra-Matic Drive or 4-on-the-floor transmission. **☞** Beyond that, you can equip it with goodies galore: new UHV Transistorized Ignition System, a variety of axle ratios, tach/engine gauge are among them. Now who's the swashbuckler in your family? Better tell the whole crew 4-4-2 is here!

**4-4-2 SPECIFICATIONS:** Wheelbase, 115"; overall length, 204.2"; overall width, 76.0"; overall height 53.6"; tire size, 7.75x14".  
**STANDARD EQUIPMENT:** 350-hp 4-4-2 Rocket V-8; heavy-duty front and rear suspension; heavy-duty wheels; heavy-duty motor mounts; Red-Line tires; bucket seats; carpeting; heater-defroster; deluxe steering wheel; full complement of Oldsmobile safety features (pages 3 and 43.)

Olds offers, at modest extra cost, a variety of options and accessories, many of which are shown in the car illustrations and described on pages 40, 41 and 46.



4-4-2 CONVERTIBLE

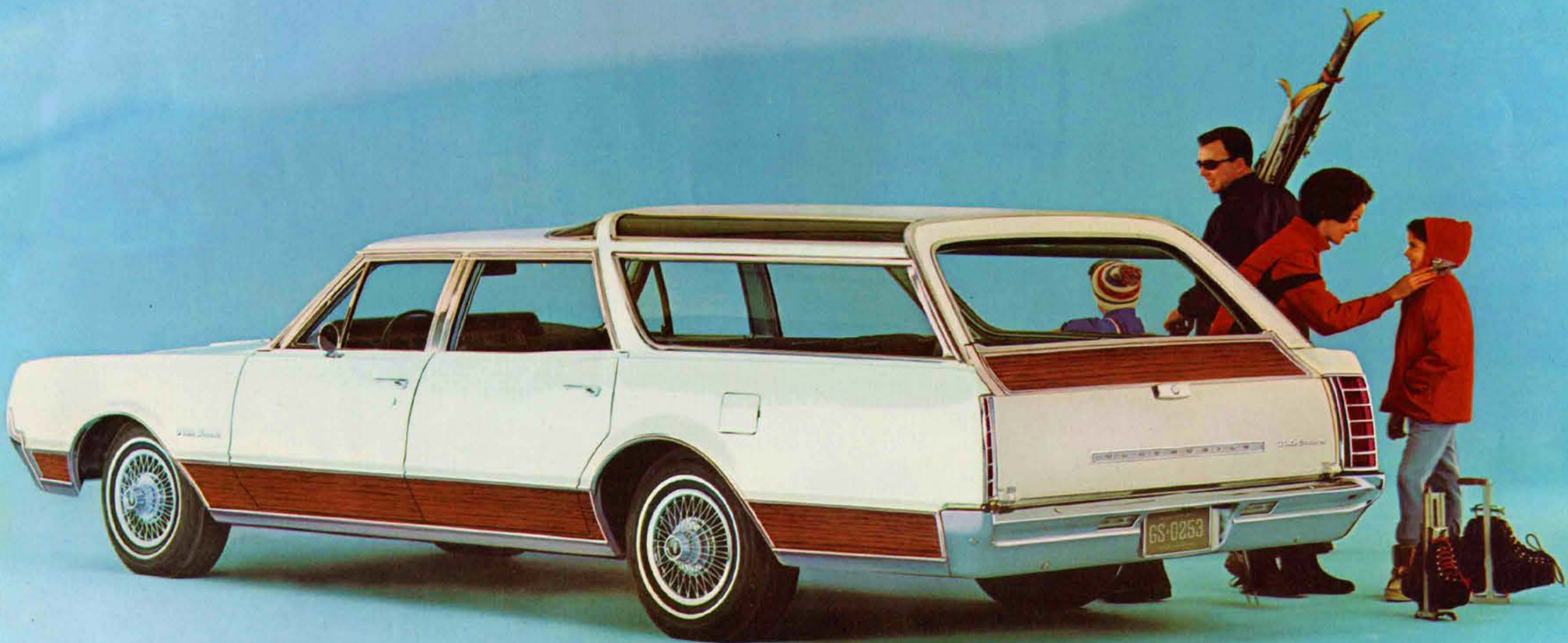

CUSTOM VISTA-CRUISER 3-SEAT WAGON



## VISTA-CRUISER WAGON

Lets you get away from it all  
—and take it all with you, too!

*If you're the kind who believes in buying the large, family economy size, here's a brand-new eye-ful that meets all the requirements: Big and stylish Olds Vista-Cruiser Station Wagon! It's yours in a sleek new three-seat model—plus two- and three-seat Custom versions that sport new exterior wood-grained vinyl panels and all the trimmings!*

☛ *Brilliant Moroccan interior takes the kids with perfect poise. Rear seats (with new seat-back latches) fold down handily to accommodate family-size cargo of over 100 cubic feet! Tinted glass Vista-Roof enhances the view. And the third seat faces front—so you can see where you're going, not where you've been!* ☛ *Below-deck luggage compartment, front carpeting, deluxe steering wheel, padded second-seat visors are all standard on the Custom Vista-Cruiser Wagon.* ☛ *And ahead of it all, Olds puts a 330-cubic-inch, regular-gas Jetfire Rocket V-8! Can you think of a better way to get away from it all—family-style?*

**VISTA-CRUISER STATION WAGON SPECIFICATIONS:** Wheelbase, 120"; overall length, 209.5"; overall width, 76.0"; overall height, 58.2"; tire size, 8.25 x 14".

*Olds offers, at modest extra cost, a variety of options and accessories, many of which are shown in the car illustrations and described on pages 40, 41 and 46.*

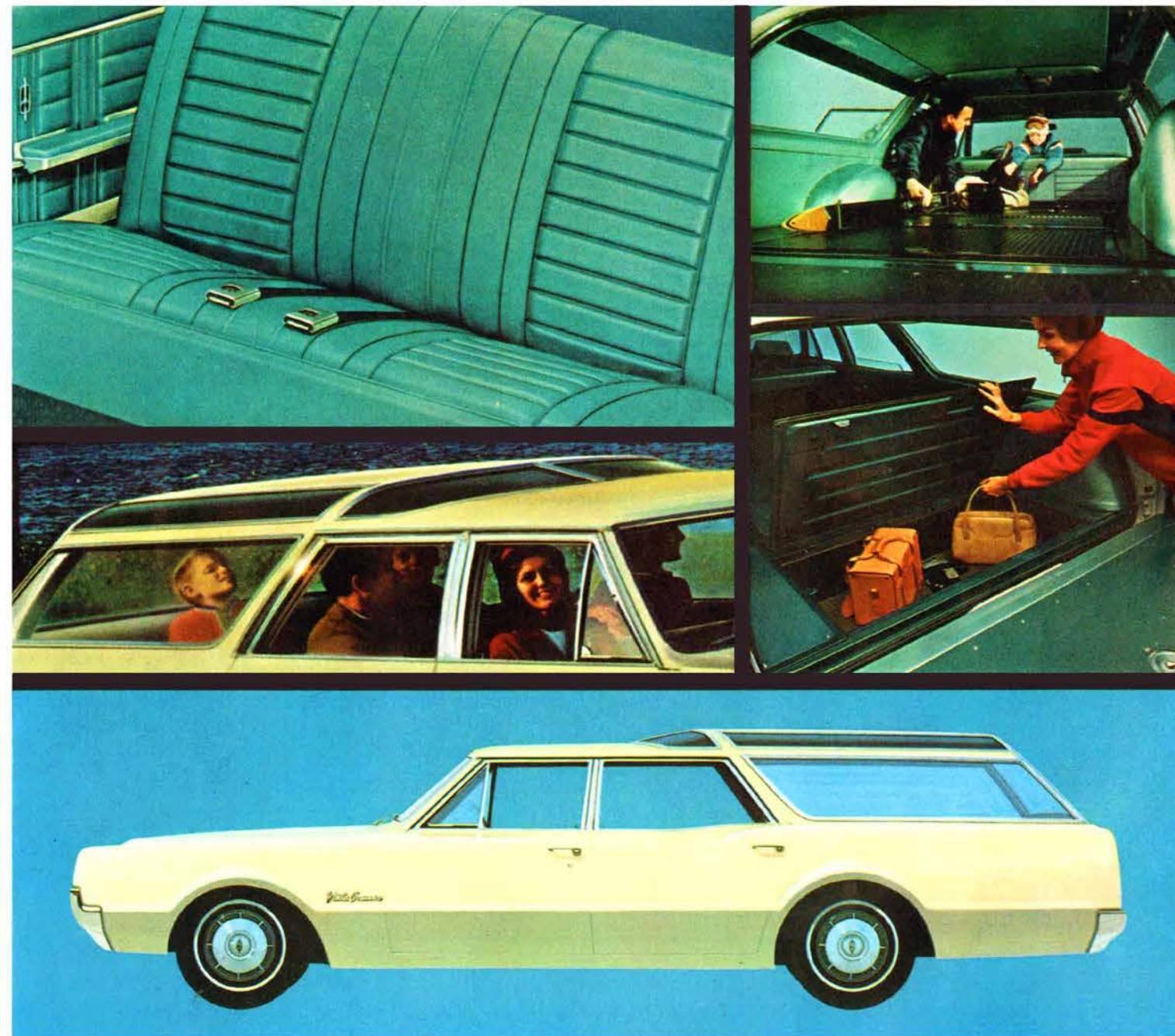

VISTA-CRUISER 3-SEAT WAGON



F-85 STATION WAGON

## CUTLASS and F-85 WAGONS



Brand-new bandwagons that save to beat the band!

*These two new Olds wagons look trim as majorettes—but get a load of all the tubas, trumpets and trombones you can pack onto that 115-inch wheelbase! Practical, washable Moroccan sparks up the interiors of both Cutlass and F-85 versions; Cutlass in four color combinations, F-85 in three. Both feature a second seat that folds down with ease to produce more than 85 cubic feet of usable load space. And, like all Olds wagons, they have a full complement of Oldsmobile safety features as standard equipment. Handsome new grille with twin triple-light design sets the style motif for these lowest-priced Olds wagons. Right back of it is either a regular-fuel, 250-hp Jetfire Rocket V-8 or a dollar-wise 155-hp Action-Line 6. All right, bandmen. All together now. The "Go-To-Your-Olds-Dealer's" March!*

**CUTLASS AND F-85 STATION WAGON SPECIFICATIONS:** Wheelbase, 115"; overall length, 204.2"; overall width, 76.0"; overall height, 55.3"; tire size, 7.75 x 14".

*Olds offers, at modest extra cost, a variety of options and accessories, many of which are shown in the car illustrations and described on pages 40, 41 and 46.*

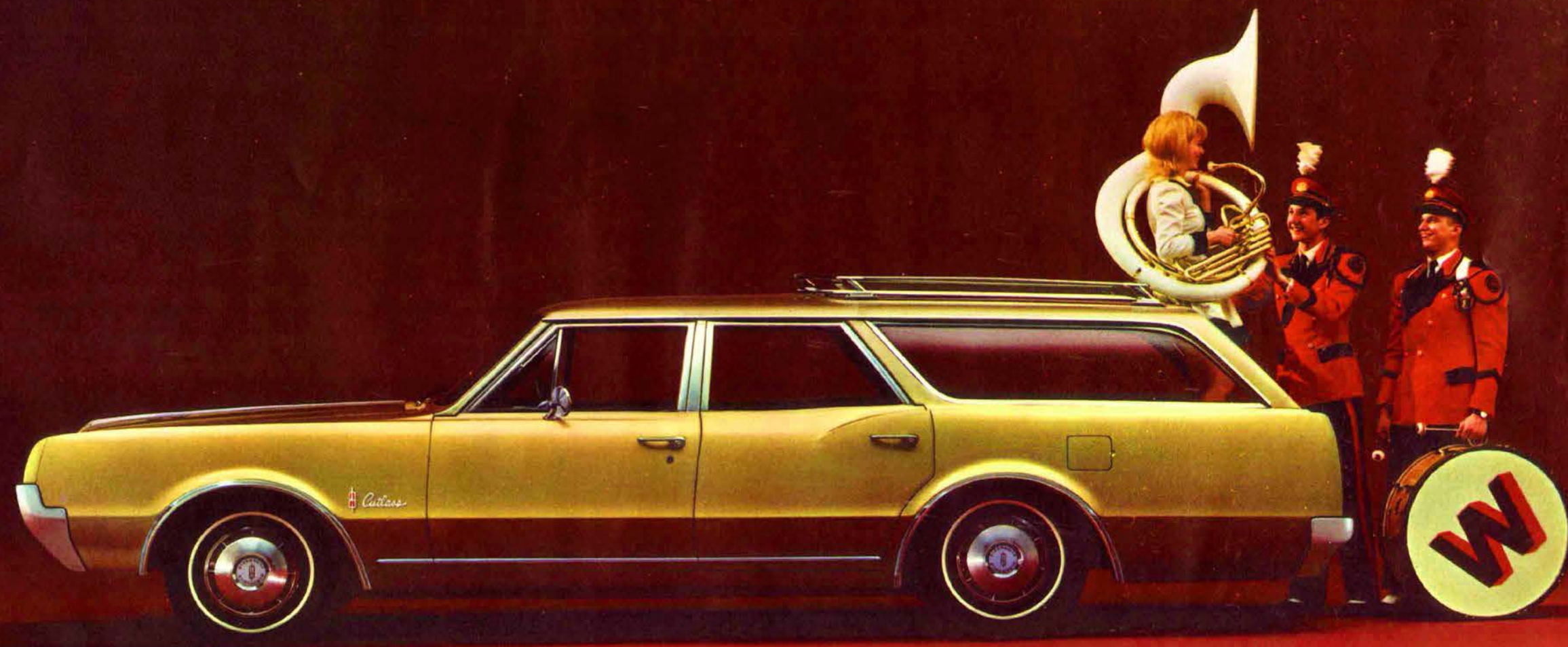

CUTLASS STATION WAGON

Climatic Combustion Control—another Olds engineering first—surrounds carburetor with summertime temperature, year 'round.

*New Climatic Combustion Control avoids carburetor icing, provides faster choke warm-up, improves fuel economy. Air is preheated by circulating around exhaust manifold, then is drawn through valve-and-diaphragm system to regulate air mixture automatically. The preheat mechanism is bypassed when full throttle is required. Another quality Olds feature—available on all Rocket V-8 Engines.*

Below, left: Incoming air enters at (A), circulates around exhaust manifold (B) where it is preheated, and goes to carburetor. Right: Thermostat (arrow) regulates air temperature at the carburetor.

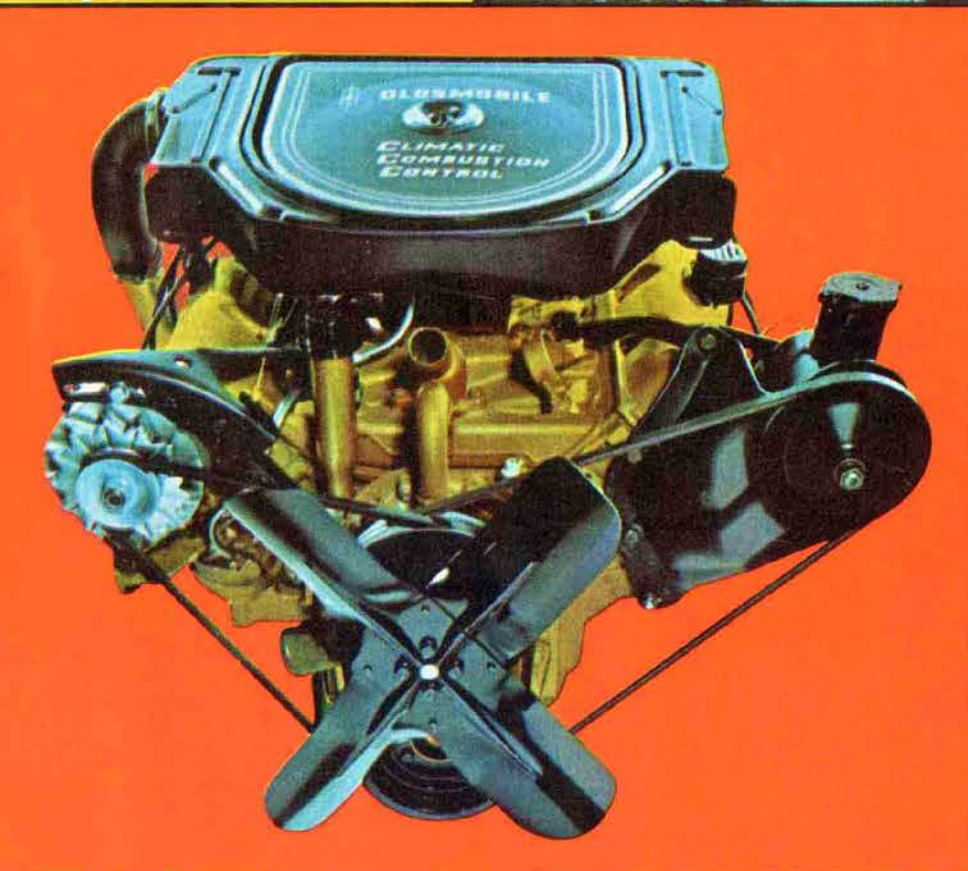

Jetfire Rocket V-8 with Oldsmobile's unique new Climatic Combustion Control.



## Engineering excellence:

No car says it more emphatically than Oldsmobile. And never was it more obvious. Meet the 1967 team of responsive Rocket Engines and transmissions...smoother-than-ever!

### Toronado Rocket V-8

Horsepower: 385.  
Torque: 480 lb.-ft.  
Displacement: 425 cu. in.  
Compression Ratio: 10.5-to-1.  
Carburetor: Quadrajets (4-barrel).  
Standard: Toronado.

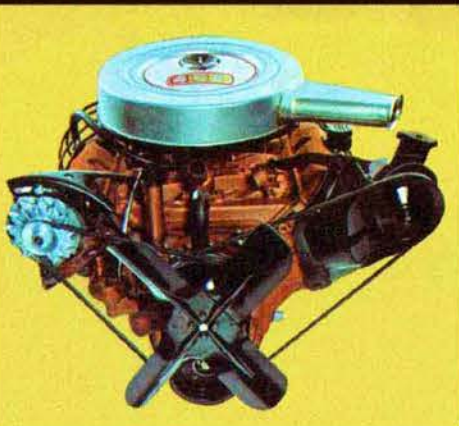
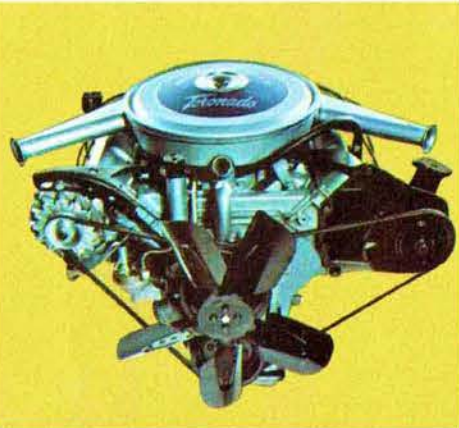

### Starfire Rocket V-8

Horsepower: 375. Torque: 470 lb.-ft.  
Displacement: 425 cu. in. Compression Ratio: 10.5-to-1. Carburetor: Quadrajets (4-barrel). Optional at extra cost: Ninety-Eight, Delta 88 Custom, Delta 88, Delmont 88 (425).

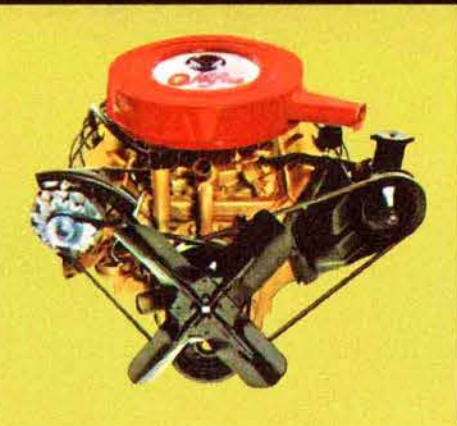

### Super Rocket V-8

Horsepower: 365. Torque: 470 lb.-ft.  
Displacement: 425 cu. in. Compression Ratio: 10.25-to-1. Carburetor: Quadrajets (4-barrel). Standard: Ninety-Eight. Optional at extra cost: Delta 88 Custom, Delta 88, Delmont 88 (425).

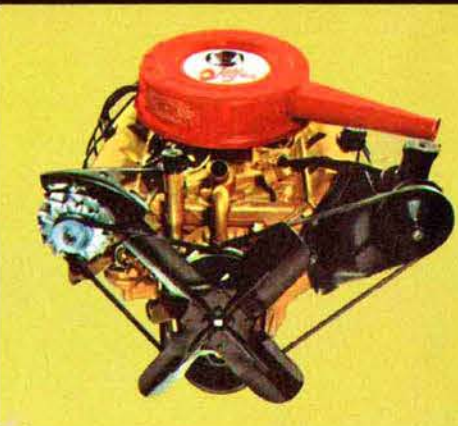
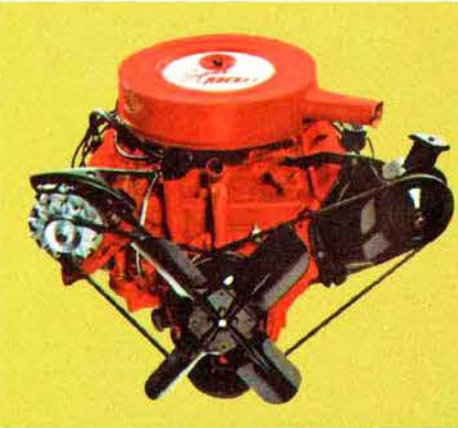

### Super Rocket V-8

Horsepower: 310. Torque: 450 lb.-ft.  
Displacement: 425 cu. in. Compression Ratio: 10.25-to-1. Carburetor: 2-barrel. Standard: Delta 88 Custom, Delta 88, Delmont 88 (425) when equipped with Turbo Hydra-Matic.

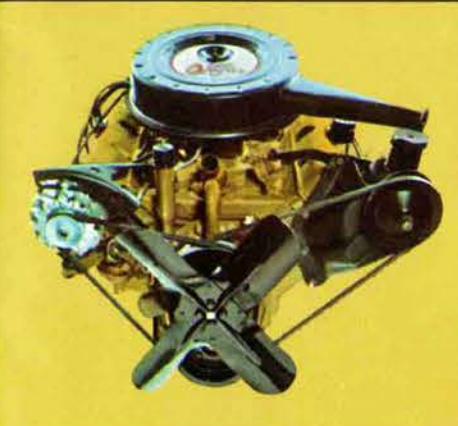

### Super Rocket V-8

Hp: 300. Torque: 430 lb.-ft.  
425 cu. in. 9.0-to-1. 2-bbl. carb. Standard: Delta 88 Custom, Delta 88, Delmont 88 (425) with manual transmission. (Optional, no extra cost, when equipped with Hydra-Matic.)

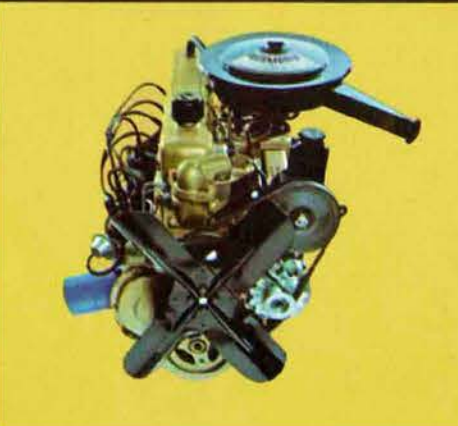
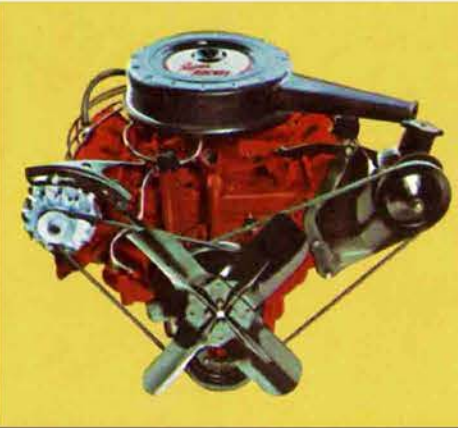

### Turbo Hydra-Matic Drive—Smoother for '67.

Variable-vane torque converter ups the power ratio. Three-speed ratio with Super range provides added engine braking on steep hills, pulling heavy loads. Standard on Toronado, Ninety-Eight. Extra-cost option on Delta 88 Custom, Delta 88, Delmont 88, 4-4-2, Vista-Cruiser.

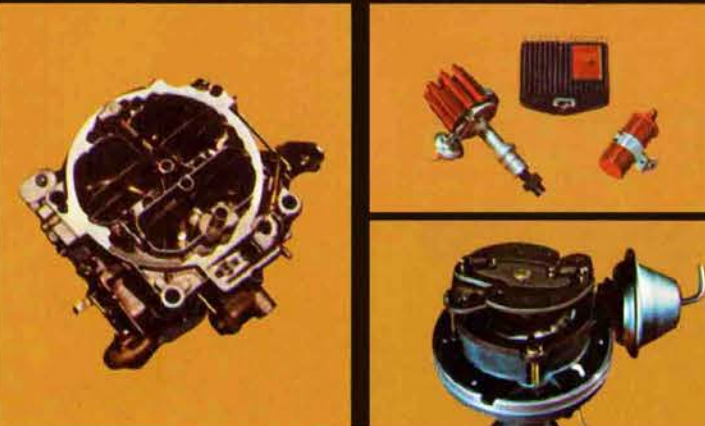
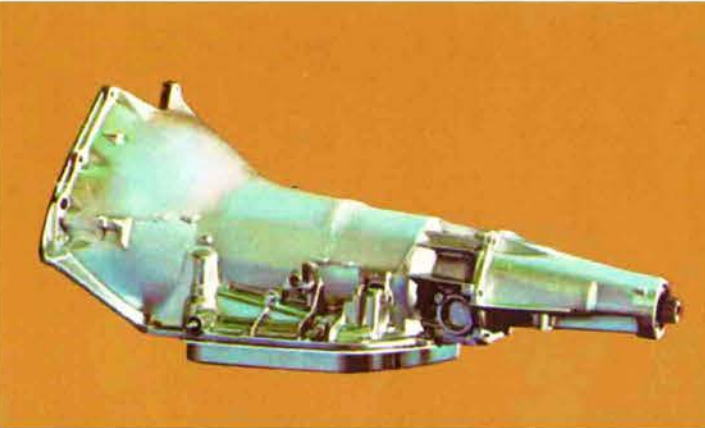

### Jetaway Drive—Slip it in "Drive" and away you go.

Two silky-smooth forward speed ranges. Variable-vane torque converter multiplies engine power, varies the pitch for smooth response from start or on the road. Optional at extra cost on Delmont 88 (330), Cutlass Supreme, Cutlass, F-85 and Vista-Cruiser models.

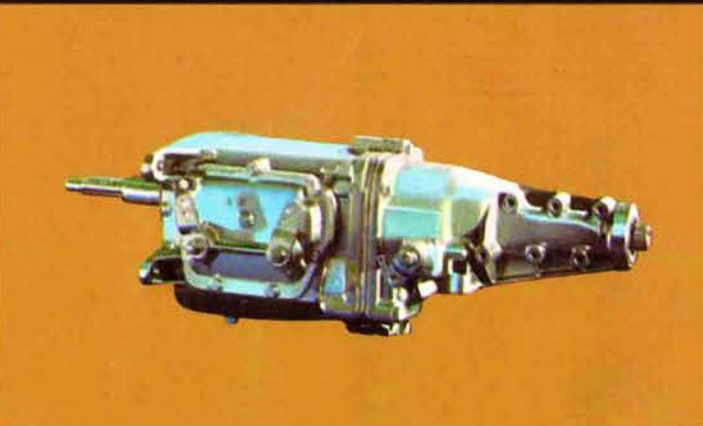
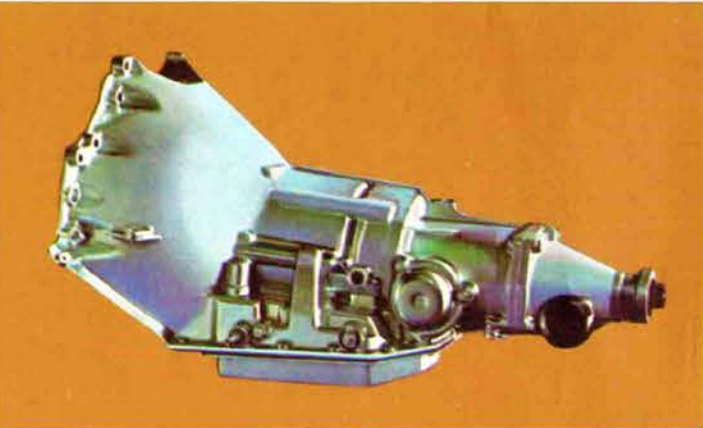

### 4-4-2 Rocket V-8

Horsepower: 350.  
Torque: 440 lb.-ft.  
Displacement: 400 cu. in.  
Compression Ratio: 10.5-to-1.  
Carburetor: Quadrajets (4-barrel).  
Standard: 4-4-2 models.



### Jetfire Rocket V-8

Horsepower: 320. Torque: 360 lb.-ft.  
Displacement: 330 cu. in. Compression Ratio: 10.25-to-1. Carburetor: Quadrajets. Standard: Cutlass Supreme. Optional at extra cost: Delmont 88 (330), Vista-Cruiser, Cutlass, F-85 models.



### Jetfire Rocket V-8

Horsepower: 260. Torque: 355 lb.-ft.  
Displacement: 330 cu. in. Compression Ratio: 10.25-to-1. Carburetor: 2-barrel. Standard: Delmont 88 (330) when equipped with Jetaway or Turbo Hydra-Matic Drive.



### Jetfire Rocket V-8

Horsepower: 250. Torque: 335 lb.-ft.  
Displacement: 330 cu. in. Compression Ratio: 9-to-1. 2-bbl. carb. Standard: Cutlass, F-85, Vista-Cruiser, Delmont 88 (330) with man. trans. No extra cost: Delmont 88 (330) with auto. trans.



### Action-Line 6

Horsepower: 155.  
Torque: 240 lb.-ft.  
Displacement: 250 cu. in.  
Compression Ratio: 8.5-to-1.  
Carburetor: 1-barrel.  
Available: F-85, Cutlass.



### Improved Quadrajets Carburetor—Four-barrel design.

Has air-metered secondary throttle bores, greater capacity. Reliability increased by eliminating needle diaphragm.



### UHV Transistorized Ignition System—No condenser. No breaker points.

Extends plug life, fires when plugs are flooded. Extra-cost option on 400- and 425-cu.-in. engines.



### Four-Speed Fully Synchronized Stick—Floor-mounted with smoother gear changes at all speeds.

Available in "wide" or "close" ratio on 4-4-2, Cutlass Supreme, Cutlass and F-85 (except six-cylinder models). Three-speed fully synchronized transmission, mounted on steering column, standard on all models except Toronado, Ninety-Eight.



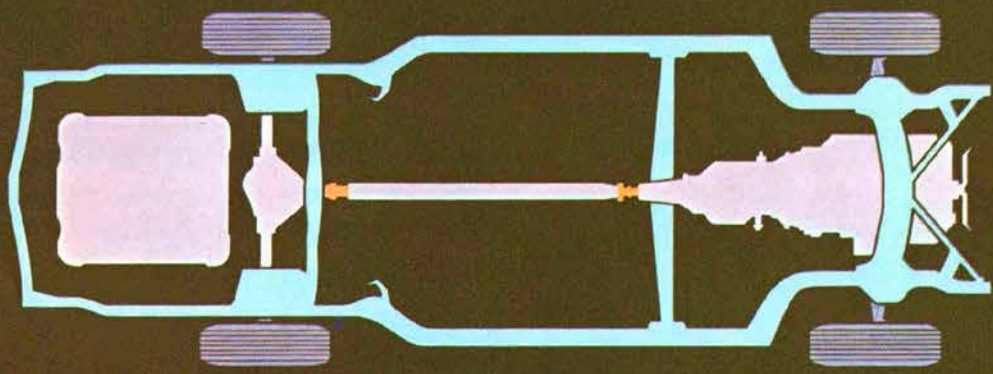

## Quality-engineered Power Profile Chassis.

Topped with solidly built Body by Fisher. Fitted with a whole inventory of scientifically tested features. Result: Every '67 Oldsmobile features the finest foundation Olds ever put together.

**A** Perimeter-type Guard-Beam Frame surrounds chassis. Torque boxes resist twists for stable, controlled ride. **B** Vibra-Tuned Body Mounts, positioned at nodal points around frame, isolate vibration. New softer rubber provides quieter, more comfortable ride. **C** Twin-Triangle Stability. Olds-pioneered rear suspension offers excellent stability, minimum wheel hop. Four-coil suspension features reduced spring rates for a smoother, softer ride.

**D** Pivot-Poise Front Suspension features new springs, shock absorbers and ball joints to soften ride, soak up road shock. **E** Sound-Deadening Body Insulation. Throughout Oldsmobile's Body by Fisher, strategically located sound-deadening materials keep passenger compartment whisper-quiet. Insulation under hood, inside doors, under floor pan, in trunk and inside fenders makes this the quietest Olds ever. **F** New Toronado Brakes. Brake balancer valve on Toronado divides brake force between front and rear. As demand on front brakes increases at higher speeds, balancer diverts more of force to front drums and shoes. **G** Finned Brake Drums. All Ninety-Eight models feature new front finned brake drums for additional cooling and efficiency. Larger power brake cylinder increases braking capacity, results in greater force with same pedal effort.

**H** Oldsmobile Designed and Built Rear Axle. Completely new design has higher capacity, operates more smoothly and quietly.



42

## Oldsmobile cares for your safety!

Builds a whole array of safety features into every Oldsmobile model —all standard equipment, at no extra cost.

**A** Energy-Absorbing Steering Column is a new safety feature. Designed in collapsible sections, column telescopes up to 8¼ inches under severe impact. **B** Front and Rear Seat Belts, with pushbutton buckles, come in a variety of colors to harmonize with interiors. Front belts are equipped with retractors. **C** Inside Day-Night Mirror. Just twist a button to cut headlight glare from cars behind. Features shatter-resistant, vinyl-edged glass and breakaway support. Outside Rearview Mirror lets you check traffic with ease before switching lanes. Remote-control mirror is optional at extra cost. **D** Padded Sun Visors. All Oldsmobiles are equipped with generously padded dual sun visors, covered in same fabric as the headlining. Padded Instrument Panel is made of glare-reducing Moroccan, matches interior decor.

**E** Backup Lights automatically switch on when car is put into reverse. Light rear area, warn oncoming drivers. **F** Soft, Low-Profile Window Control Knobs are color-keyed to interior. Coat hooks are soft too. **G** Smooth, Contoured Knobs and Levers are a feature of energy-absorbing instrument panel. **H** Folding-Seat-Back Latches are standard on wagons and on front seats of two-door models to keep split seat backs from folding forward. Manual release is located on seat side, or under the seat itself.

**I** Lane Change Feature is incorporated in direction-signal control, lets you operate turn signals at halfway position, returns to "off" position automatically. **J** Dual-Speed Windshield Wipers and Washer. Wipers can be regulated for light or heavy rain, are integral with washer. Wiper arms and blades have reduced-glare finish. **K** Passenger-Guard Door Locks on all doors prevent accidental opening of doors with handles. Buttons must be pulled up to unlock. **L** Four-Way Hazard Warning Flasher. Convenient switch located on steering column activates all four turn signals, flashes warning to other drivers. **M** Dual Master Cylinder Brake System. New Dual Master Cylinder is added safety feature for '67, separates front and rear braking systems so that fluid levels of both are independent. Brake Warning Light indicates when parking brake is engaged or fluid level is low in dual master cylinder brake system.

Other standard safety features on all 1967 Oldsmobiles include: Front-Seat Shoulder Belt Anchors, Tire Safety Rim, Corrosion-Resistant Brake Lines, Energy-Absorbing Steering Wheel, Safety Door Latches and Hinges, Uniform Shift Quadrant (PRNDL) and Thick Laminated Windshield.

Obey  
Laws  
Drive  
Safely

43

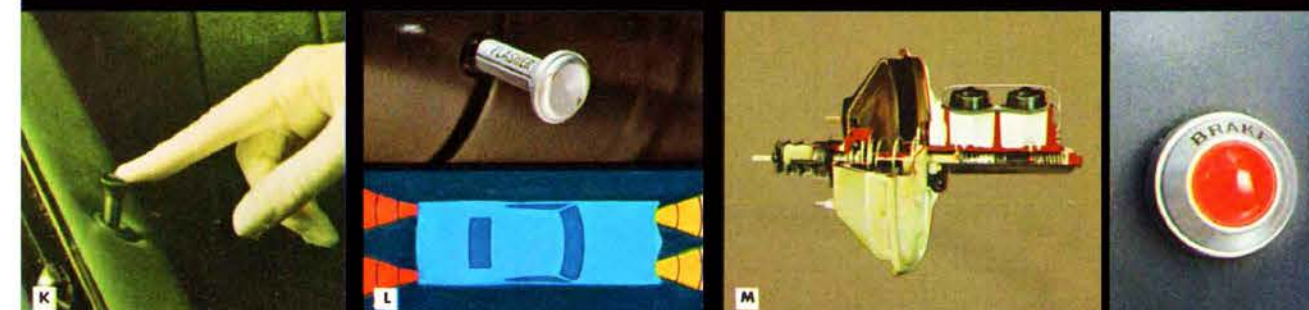
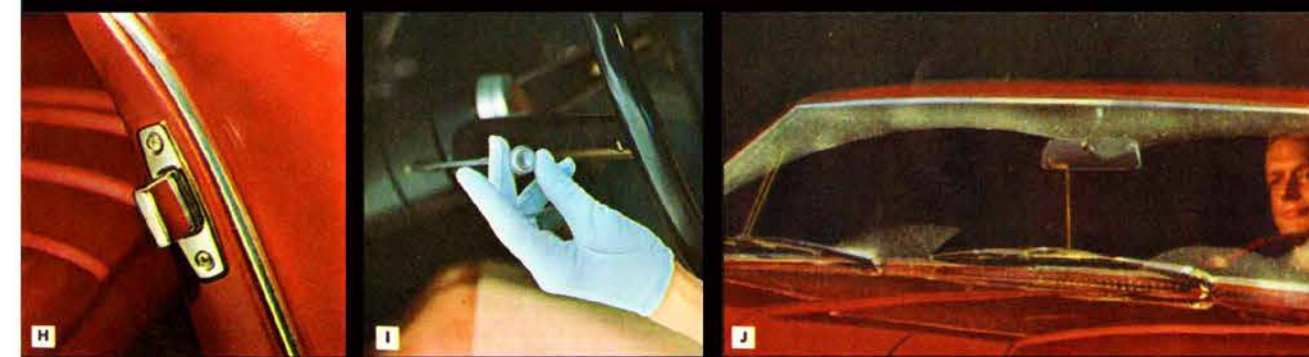
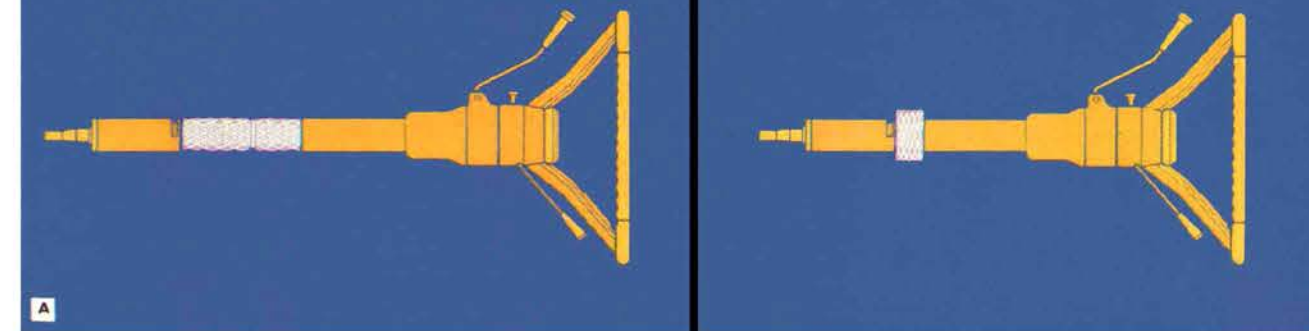

### Toronado

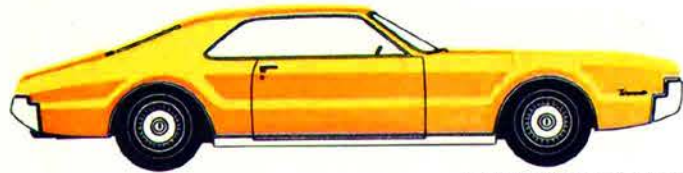

TORONADO DELUXE

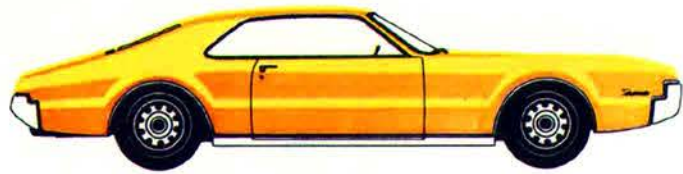

TORONADO

### Ninety-Eight



LUXURY SEDAN

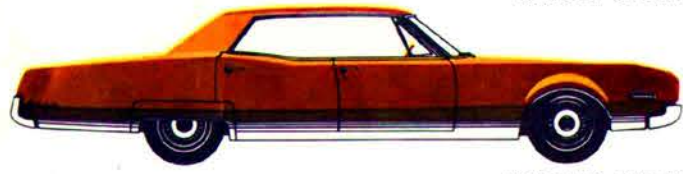

HOLIDAY SEDAN



TOWN SEDAN



HOLIDAY COUPE

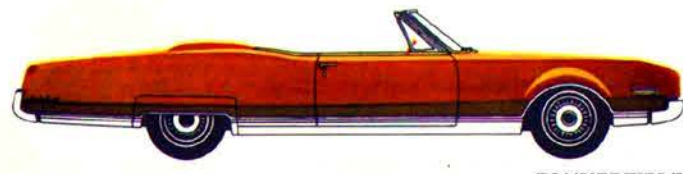

CONVERTIBLE

### Delta 88 Custom

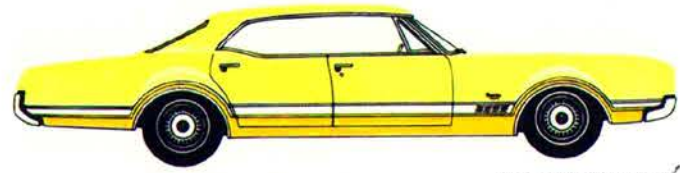

HOLIDAY SEDAN

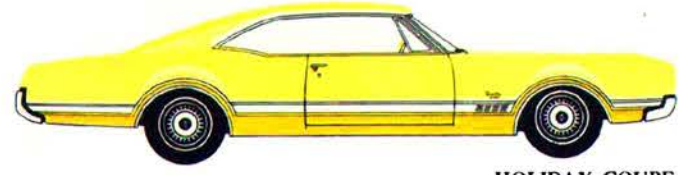

HOLIDAY COUPE

### Delta 88

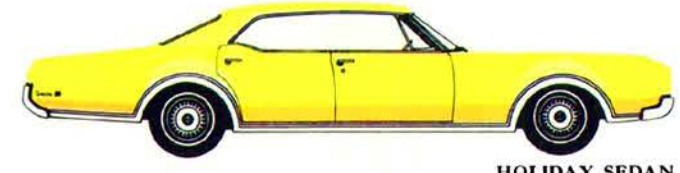

HOLIDAY SEDAN



TOWN SEDAN

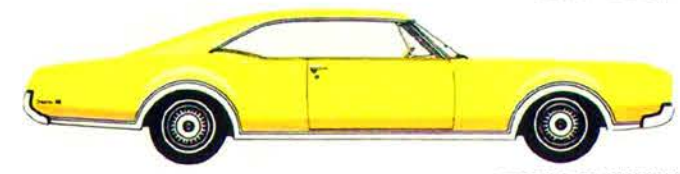

HOLIDAY COUPE

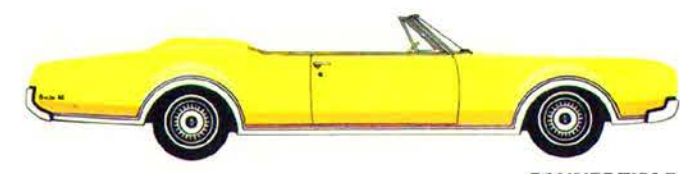

CONVERTIBLE

### Delmont 88



HOLIDAY SEDAN



TOWN SEDAN



HOLIDAY COUPE

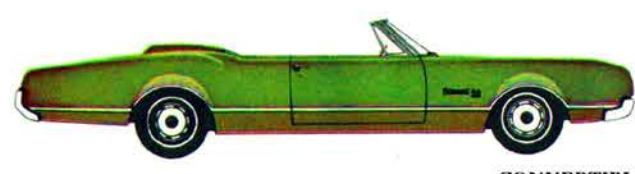

CONVERTIBLE

### Cutlass Supreme



HOLIDAY SEDAN



TOWN SEDAN



HOLIDAY COUPE



SPORTS COUPE



CONVERTIBLE

### 4-4-2



HOLIDAY COUPE



SPORTS COUPE



CONVERTIBLE

### Cutlass



HOLIDAY SEDAN



TOWN SEDAN



HOLIDAY COUPE



CONVERTIBLE

### F-85



TOWN SEDAN



CLUB COUPE

### Vista-Cruiser Station Wagon



CUSTOM 3-SEAT WAGON



CUSTOM 2-SEAT WAGON



3-SEAT WAGON

### Cutlass and F-85 Station Wagons



CUTLASS STATION WAGON



F-85 STATION WAGON

Luxury models. Economy models. Sports models. Wagons. Convertibles. Olds is here in a big way for 1967 . . . with 36 glamorous Toronado-inspired models to please everyone from the luxury-lover to the low-price buyer. All featuring Oldsmobile's traditionally exacting quality. All featuring Oldsmobile's inimitable Rocket Action. All decked out with a wide selection of exclusive Oldsmobile engineering features. And, naturally, a whole array of thoughtfully-designed safety features. Plus a complete assortment of options and accessories that lets you virtually tailor your Olds to your requirements. This Glossary of Models is presented to simplify your selection. Next move: A test drive at your Olds Dealer's!

Olds offers, at modest extra cost, a variety of options and accessories, many of which are shown in the car illustrations and described on pages 40, 41 and 46.

Olds is out front again—with a Rocket to fit your pocket!

## OLDSMOBILE OPTIONS AND ACCESSORIES

Available at modest extra cost  
for your personalized comfort and convenience

**A** New Stereo Tape Player gives you the concert-hall realism of full-range musical entertainment. Eight-track tape cartridge slips easily into player conveniently mounted under instrument panel. Available on Toronado, Ninety-Eight and 88s only.

**B** Four-Season Air Conditioning keeps the interior of your Oldsmobile cool and fresh, reduces humidity and pollen. Cools in seconds, even in hottest weather.

Four-Season Air Conditioning with Comfortron—available on all full-size Oldsmobiles—provides the added convenience of automatic temperature control. **C** Reclining Seat lets front passenger change position as much as 30°. Pays off in reduced fatigue, especially on long trips. Available on Toronado Deluxe, Ninety-Eight Convertible, Delta 88 Custom, Cutlass Supreme Convertible and Coupes. **D** Front-Seat Headrests adjust to three positions to give you the added support you want. Come color-keyed to your interior trim. Available in pairs on all '67 models.

**E** Cruise-Control lets you maintain a constant speed on turnpikes. Built-in warning device tells you when speed setting has been reached. Automatically disengages when brake is used.

**F** AM-FM Radio gives you a wider selection of stations to fit any listening mood. Available on all Oldsmobiles for '67. Power antenna and rear-seat speaker are offered at extra cost. AM-FM Stereo Radio adds an exciting new dimension to your driving enjoyment. Comes

with front- and rear-seat speakers. Available: Toronado, Ninety-Eight and 88s. **G** Cornering Lights let you see where you're turning, are visible from side. Available on Toronado, Ninety-Eight and 88s.

The following additional accessories are available at modest extra cost on many Oldsmobile models: Tilt-and-Telescope Steering Wheel adjusts in-and-out, up-and-down to suit your personal driving preference. Makes it easier to enter and leave the car. Tilt-Away Steering Wheel allows easy up-and-down adjustment for your increased driving comfort.

Power Steering • Power Brakes • Power Windows • Power Seat • Power Ventipanes • Power Door Locks • Rear Window Defogger • Safety Sentinel • Soft-Ray Tinted Windows • Power Deck-Lid Release • Sports Console • Whitewall Tires • Deluxe Wheel Discs • Simulated Wire Wheels • Super Stock Wheels • Dual Exhausts • Courtesy Lights • Clock • Tachometer • Station Wagon Luggage Rack • Ski Rack • Power Tailgate Window • Disc Brakes • Chrome Window Moldings • Chrome Door-Edge Moldings • Anti-Spin Rear Axle.

Accessories and power features described in this catalog are optional at extra cost, unless otherwise specified. A partial list of accessories appears above. A full price list for all models and options is available at your nearest Olds Quality Dealer's.

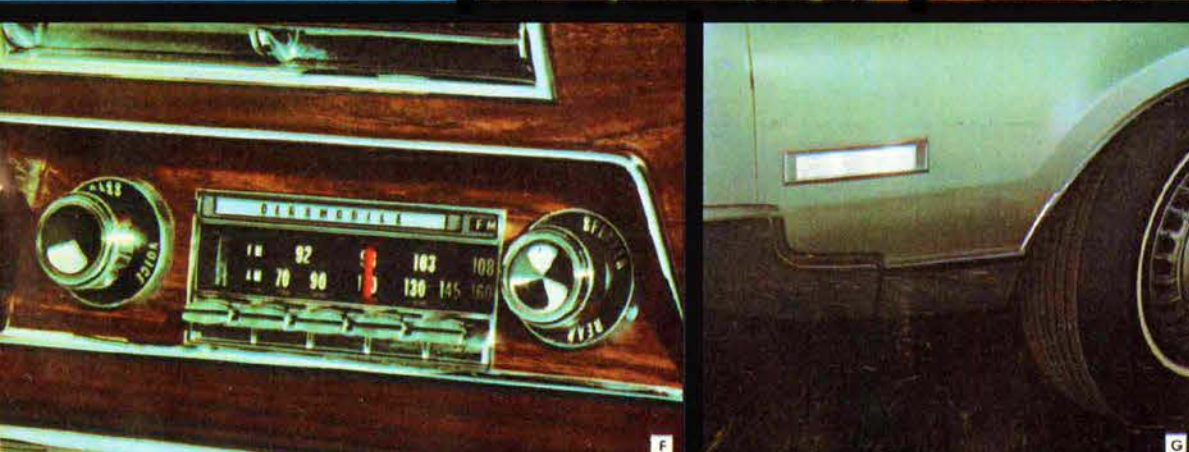
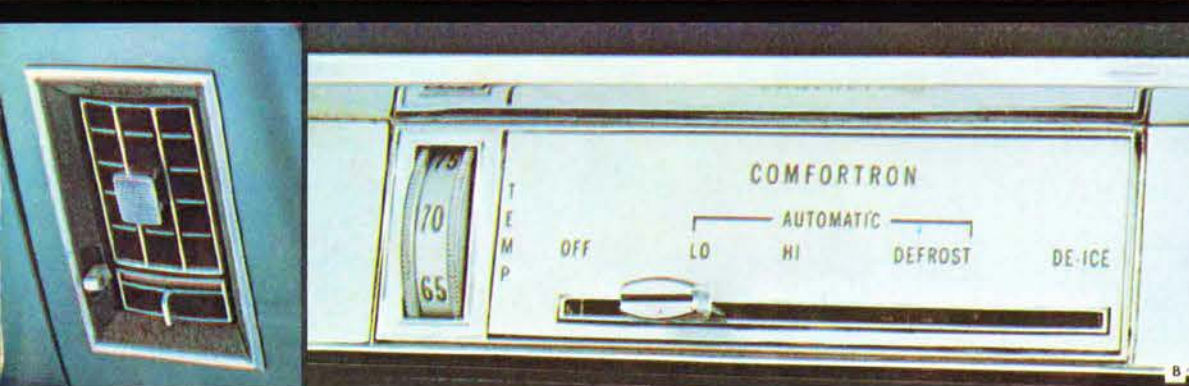
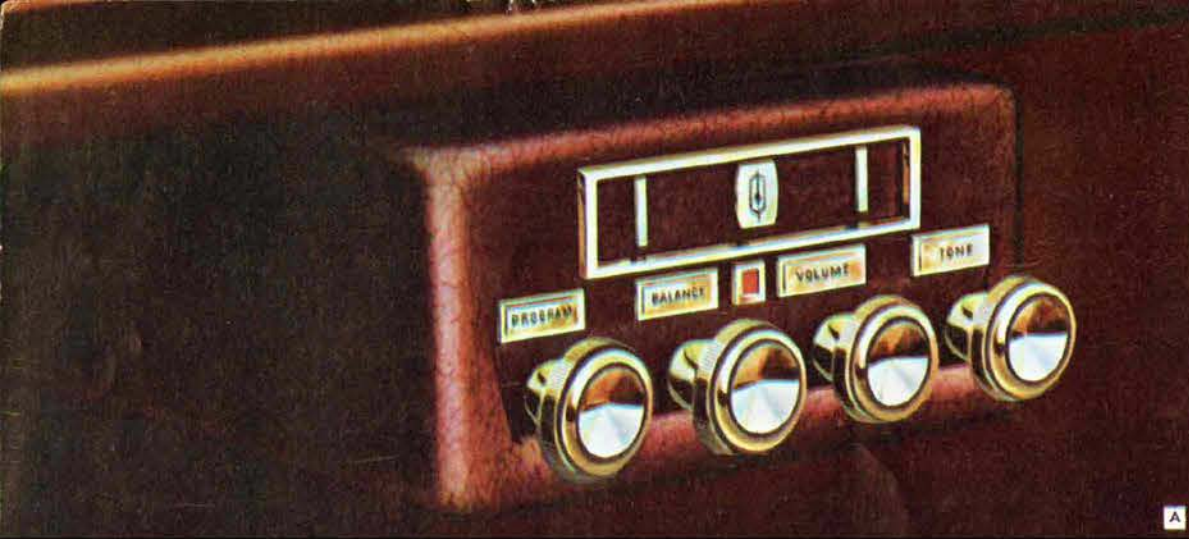



GENERAL	TORONADO	NINETY-EIGHT	DELTA 88 CUSTOM	DELTA 88	DELMONT 88	CUTLASS SUPREME	CUTLASS	F-85	4-4-2	VISTA-CRUISER
Wheelbase	119"	126"	123"	123"	123"	115"	115"	115"	115"	120"
Overall length	211.0"	223.0"	217.0"	217.0"	217.0"	204.2"	204.2"	204.2"	204.2"	209.5"
Overall width	78.5"	80.0"	80.0"	80.0"	80.0"	76.0"	76.0"	76.0"	76.0"	76.0"
Overall height*	52.8"	55.8"	54.5"	55.5"	55.5"	54.4"	54.4"	54.4"	53.6"	58.2"
Curb wt. (lbs.)*	4472	4413	4263	4184	4146	3421	3387	3365	3684	3948
Fuel Cap. (gals.)	24	25	25	25	25	20	20	20	20	20
Headroom* (frt./rear)	37.9"/37.3"	39.5"/38.2"	38.1"/37.3"	38.7"/37.9"	38.7"/37.9"	38.1"/37.3"	38.1"/37.3"	38.1"/37.3"	37.7"/36.2"	38.0"/40.5"
Legroom* (frt./rear)	41.2"/35.5"	41.0"/42.2"	41.3"/38.7"	41.1"/39.0"	41.1"/39.0"	41.2"/35.9"	41.2"/35.9"	41.0"/36.0"	41.7"/32.3"	41.6"/38.9"
Hiproom* (frt./rear)	62.2"/55.6"	63.5"/62.6"	63.8"/62.9"	63.6"/62.6"	63.7"/62.8"	59.9"/59.9"	59.9"/59.9"	59.9"/59.9"	59.7"/52.9"	59.6"/59.7"
Tread (frt./rear)	63.5"/63"	62.5"/63"	62.5"/63"	62.5"/63"	62.5"/63"	58"/59"	58"/59"	58"/59"	58"/59"	58"/59"
Tire size	8.85 x 15"	8.85 x 14"	8.55 x 14"	8.55 x 14"	8.55 x 14"	7.75 x 14"	7.75 x 14"	7.75 x 14"	7.75 x 14"	8.25 x 14"
Axle ratio (auto. trans.)	3.21	3.08	2.93	2.93	2.93 <sup>1</sup>	3.08	2.78	2.78	3.08	3.08

\*Town Sedan; Holiday Sedan on Delta 88 Custom; Holiday Coupe on 4-4-2

<sup>1</sup>2.78 (330)

ENGINES	HP	TORQUE	DISPL., CU. IN.	COMP. RATIO	CARB., (bbls.)	FUEL	AVAILABILITY
Toronado Rocket V-8	385	480	425	10.5	4	Prem.	Toronado only
Starfire V-8	375	470	425	10.5	4	Prem.	Optional at extra cost on Ninety-Eight, Delta 88 Custom, Delta 88 and Delmont 88 (425)
Super Rocket V-8	365	470	425	10.25	4	Prem.	Ninety-Eight—optional at extra cost on Delta 88 Custom, Delta 88 and Delmont 88 (425)
Super Rocket V-8	310	450	425	10.25	2	Prem.	Delta 88 Custom, Delta 88 and Delmont 88 (425)
Super Rocket V-8	300	430	425	9.0	2	Reg.	Delta 88 Custom, Delta 88 and Delmont 88 (425)
Jetfire Rocket V-8	320	360	330	10.25	4	Prem.	Cutlass Supreme—optional at extra cost on Delmont 88 (330), Cutlass, F-85 and Vista-Cruiser
Jetfire Rocket V-8	260	355	330	10.25	2	Prem.	Delmont 88
Jetfire Rocket V-8	250	335	330	9.0	2	Reg.	Cutlass, F-85, Vista-Cruiser. No extra cost on Delmont 88 (330)
4-4-2 Rocket V-8	350	440	400	10.5	4	Prem.	4-4-2 only
Rocket 400	300	425	400	10.5	2	Prem.	Included as part of extra-cost Turnpike Cruising Package on Cutlass Supreme two-door models
Action-Line 6	155	240	250	8.5	1	Reg.	Available on Cutlass and F-85

## EQUIPMENT

Additional standard features can be found on pages 3, 42 and 43.

	TORONADO	NINETY-EIGHT	DELTA 88 CUSTOM	DELTA 88	DELMONT 88	CUTLASS SUPREME	CUTLASS	F-85	4-4-2	VISTA-CRUISER
Turbo Hydra-Matic	Std.	Std.	*	*	*	—	—	—	*	*
Jetaway Drive	—	—	—	—	*	*	*	*	—	*
Power Steering	Std.	Std.	*	*	*	*	*	*	*	*
Power Brakes	Std.	Std.	*	*	*	*	*	*	*	*
Power Windows	*	Std. <sup>1</sup>	*	*	*	*	*	*	*	*
Power Seat	*	Std. <sup>1</sup>	*	*	*	*	*	*	*	*
Deluxe Steering Wheel	Std.	Std.	Std.	Std.	*	Std.	*	*	Std.	Std. <sup>2</sup>
Foam Padded Front Seat	Std.	Std.	Std.	Std.	*	Std.	*	*	Std.	Std. <sup>2</sup>
Strato Bench Seat	Std. <sup>3</sup>	Std. <sup>4</sup>	Std.	—	—	—	—	—	—	—
Strato Bucket Seat	**	—	Std. <sup>5</sup>	—	—	Std. <sup>6</sup>	—	—	Std.	—
Clock	Std.	Std.	Std.	*	*	*	*	*	*	*
Wheel Discs	*	Std.	Std.	Std.	Std.	*	*	*	*	*

\*Optional at extra cost <sup>1</sup>Extra cost on Town Sedan <sup>2</sup>Extra cost on standard model <sup>3</sup>Toronado Deluxe only <sup>4</sup>Convertible only  
 \*\*Optional no extra cost, Deluxe only <sup>5</sup>Coupe only <sup>6</sup>Not available on Holiday or Town Sedan

Oldsmobile reserves the right to make changes at any time, without notice, in prices, colors, materials, equipment, specifications and models, and also to discontinue models. 9-66 Litho in U.S.A.

# '67 OLDSMOBILE



*The Rocket Action Cars  
are Out Front Again!*

GENERAL	TORONADO	NINETY-EIGHT	DELTA 88 CUSTOM	DELTA 88	DELMONT 88	CUTLASS SUPREME	CUTLASS	F-85	4-4-2	VISTA-CRUISER
Wheelbase	119"	126"	123"	123"	123"	115"	115"	115"	115"	120"
Overall length	211.0"	223.0"	217.0"	217.0"	217.0"	204.2"	204.2"	204.2"	204.2"	209.5"
Overall width	78.5"	80.0"	80.0"	80.0"	80.0"	76.0"	76.0"	76.0"	76.0"	76.0"
Overall height*	52.8"	55.8"	54.5"	55.5"	55.5"	54.4"	54.4"	54.4"	53.6"	58.2"
Curb wt. (lbs.)*	4472	4413	4263	4184	4146	3421	3387	3365	3684	3948
Fuel Cap. (gals.)	24	25	25	25	25	20	20	20	20	20
Headroom* (frt./rear)	37.9"/37.3"	39.5"/38.2"	38.1"/37.3"	38.7"/37.9"	38.7"/37.9"	38.1"/37.3"	38.1"/37.3"	38.1"/37.3"	37.7"/36.2"	38.0"/40.5"
Legroom* (frt./rear)	41.2"/35.5"	41.0"/42.2"	41.3"/38.7"	41.1"/39.0"	41.1"/39.0"	41.2"/35.9"	41.2"/35.9"	41.0"/36.0"	41.7"/32.3"	41.6"/38.9"
Hiproom* (frt./rear)	62.2"/55.6"	63.5"/62.6"	63.8"/62.9"	63.6"/62.6"	63.7"/62.8"	59.9"/59.9"	59.9"/59.9"	59.9"/59.9"	59.7"/52.9"	59.6"/59.7"
Tread (frt./rear)	63.5"/63"	62.5"/63"	62.5"/63"	62.5"/63"	62.5"/63"	58"/59"	58"/59"	58"/59"	58"/59"	58"/59"
Tire size	8.85 x 15"	8.85 x 14"	8.55 x 14"	8.55 x 14"	8.55 x 14"	7.75 x 14"	7.75 x 14"	7.75 x 14"	7.75 x 14"	8.25 x 14"
Axle ratio (auto. trans.)	3.21	3.08	2.93	2.93	2.93	3.08	2.78	2.78	3.08	3.08

\*Town Sedan, Holiday Sedan on Delta 88 Custom; Holiday Coupe on 4-4-2 12.78 (330)

ENGINES	HP	TORQUE	DISPL., CU. IN.	COMP. RATIO	CARB., (bbls.)	FUEL	AVAILABILITY
Toronto Rocket V-8	385	480	425	10.5	4	Prem.	Toronto only
Starfire V-8	375	470	425	10.5	4	Prem.	Optional at extra cost on Ninety-Eight, Delta 88 Custom, Delta 88 and Delmont 88 (425)
Super Rocket V-8	365	470	425	10.25	4	Prem.	Ninety-Eight—optional at extra cost on Delta 88 Custom, Delta 88 and Delmont 88 (425)
Super Rocket V-8	310	450	425	10.25	2	Prem.	Delta 88 Custom, Delta 88 and Delmont 88 (425)
Super Rocket V-8	300	430	425	9.0	2	Reg.	Delta 88 Custom, Delta 88 and Delmont 88 (425)
Jetfire Rocket V-8	320	360	330	10.25	4	Prem.	Cutlass Supreme—optional at extra cost on Delmont 88 (330), Cutlass, F-85 and Vista-Cruiser
Jetfire Rocket V-8	260	355	330	10.25	2	Prem.	Delmont 88
Jetfire Rocket V-8	250	335	330	9.0	2	Reg.	Cutlass, F-85, Vista-Cruiser. No extra cost on Delmont 88 (330)
4-4-2 Rocket V-8	350	440	400	10.5	4	Prem.	4-4-2 only
Rocket 400	300	425	400	10.5	2	Prem.	Included as part of extra-cost Turnpike Cruising Package on Cutlass Supreme two-door models
Action-Line 6	155	240	250	8.5	1	Reg.	Available on Cutlass and F-85

EQUIPMENT	TORONADO	NINETY-EIGHT	DELTA 88 CUSTOM	DELTA 88	DELMONT 88	CUTLASS SUPREME	CUTLASS	F-85	4-4-2	VISTA-CRUISER
Turbo Hydra-Matic	Std.	Std.	*	*	*	—	—	—	*	*
Jetaway Drive	—	—	—	—	*	*	*	*	—	*
Power Steering	Std.	Std.	*	*	*	*	*	*	*	*
Power Brakes	Std.	Std.	*	*	*	*	*	*	*	*
Power Windows	*	Std. <sup>1</sup>	*	*	*	*	*	*	*	*
Power Seat	*	Std. <sup>1</sup>	*	*	*	*	*	*	*	*
Deluxe Steering Wheel	Std.	Std.	Std.	Std.	*	Std.	*	*	Std.	Std. <sup>2</sup>
Foam Padded Front Seat	Std.	Std.	Std.	Std.	*	Std.	*	*	Std.	Std. <sup>2</sup>
Strato Bench Seat	Std. <sup>3</sup>	Std. <sup>4</sup>	Std.	—	—	—	—	—	—	—
Strato Bucket Seat	**	—	Std. <sup>3</sup>	—	—	Std. <sup>6</sup>	—	—	Std.	—
Clock	Std.	Std.	Std.	*	*	*	*	*	*	*
Wheel Discs	*	Std.	Std.	Std.	Std.	*	*	*	*	*

\*Optional at extra cost <sup>1</sup>Extra cost on Town Sedan <sup>2</sup>Extra cost on standard model <sup>3</sup>Toronto Deluxe only <sup>4</sup>Convertible only  
 \*\*Optional no extra cost, Deluxe only <sup>5</sup>Coupe only <sup>6</sup>Not available on Holiday or Town Sedan  
 Oldsmobile reserves the right to make changes at any time, without notice, in prices, colors, materials, equipment, specifications and models, and also to discontinue models. 9-66 Litho in U.S.A.



'67 OLDSMOBILE

The Rocket Action Cars are Out Front Again!

'67 OLDSMOBILE

The Rocket Action Cars are Out Front Again!