

Chevrolet

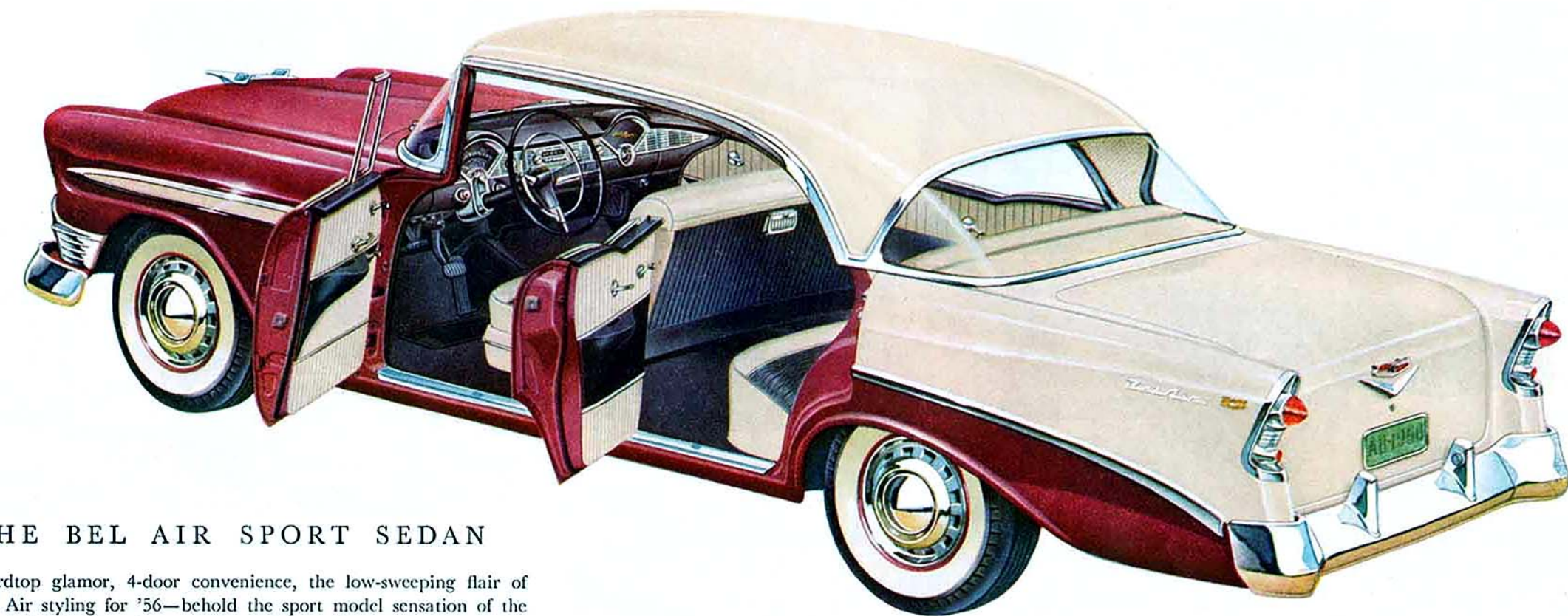

*offering a
bigger, brighter
choice than ever!*

19 LIVELY NEW CHEVROLETS FOR 1956!



THE BEL AIR SPORT SEDAN

Hardtop glamor, 4-door convenience, the low-sweeping flair of Bel Air styling for '56—behold the sport model sensation of the year! Inside—luxurious comfort, plenty of room for six, and a promise of sheer pleasure behind the wheel! Notice how the rear doors are hinged to sturdy body members. That's the key to sport sedan design, giving you virtually unobstructed vision all around.

Starring the most glamorous 4-Door Sport Sedans in any price class!

Not one, but *two*—a Sport Sedan in both the Bel Air and "Two-Ten" series!



THE BEL AIR 4-DOOR SEDAN

In each of Chevrolet's three great series, fine-car quality has been delightfully blended with heart-stirring, high-stepping performance. Each series has a fresh '56 look of its own—intriguing variations of speedline styling from crisp new grille to rakish rear fenders! Each its own distinctively styled two-tone upholstery and trim! In many models, Custom-Colored interiors are available at extra cost.



THE "TWO-TEN" SPORT SEDAN



THE "TWO-TEN" 4-DOOR SEDAN

BEL AIR SEDAN INTERIOR

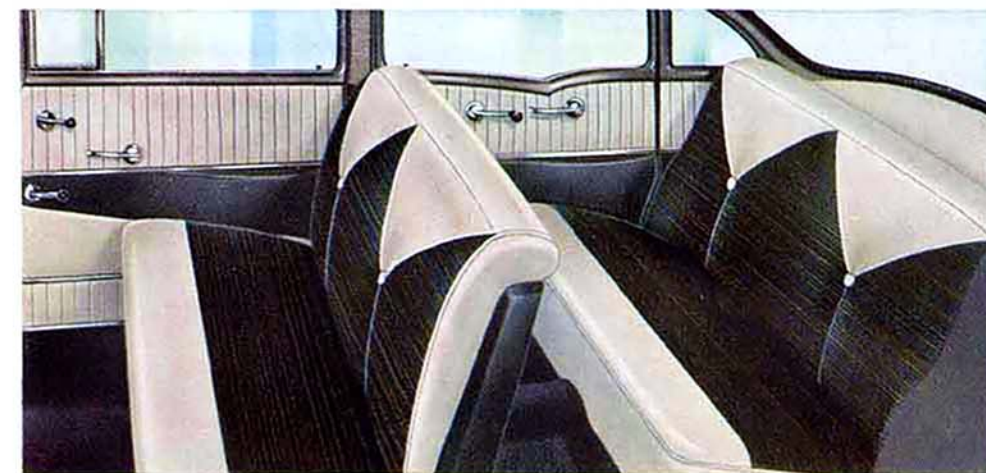

*Charcoal Gray pattern cloth with Ivory leather-grain vinyl trim.



THE "ONE-FIFTY" 4-DOOR SEDAN

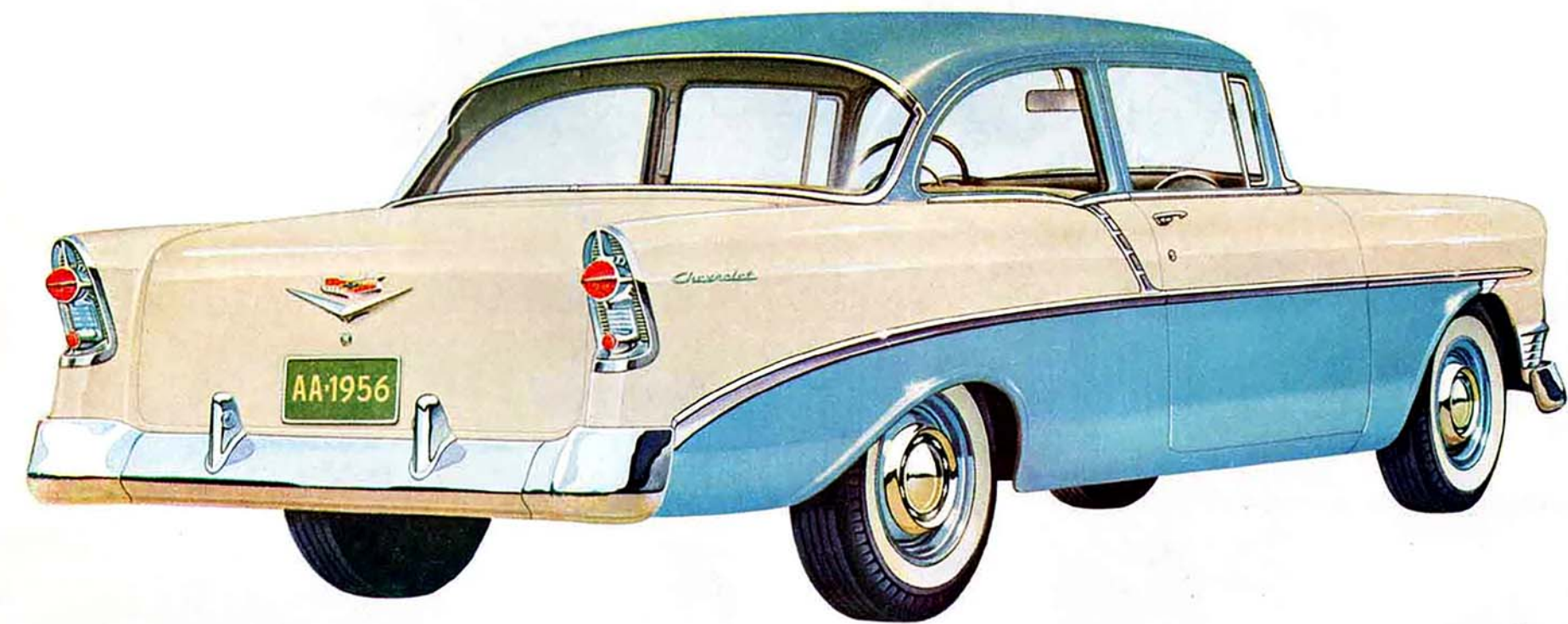

THE "TWO-TEN" 2-DOOR SEDAN

Choose your favorite from this lively trio of Chevrolet 2-door sedans. All offer glorious new colors, fresh, clean-lined good looks... they're thrillingly eager from the moment you turn the key... yet list for a price that's pleasantly and surprisingly low.



THE BEL AIR 2-DOOR SEDAN



THE "ONE-FIFTY" 2-DOOR SEDAN

"TWO-TEN" SEDAN INTERIOR



Illustrated in Custom-Colored Dark Blue pattern cloth with Starfrost leather-grain vinyl trim.

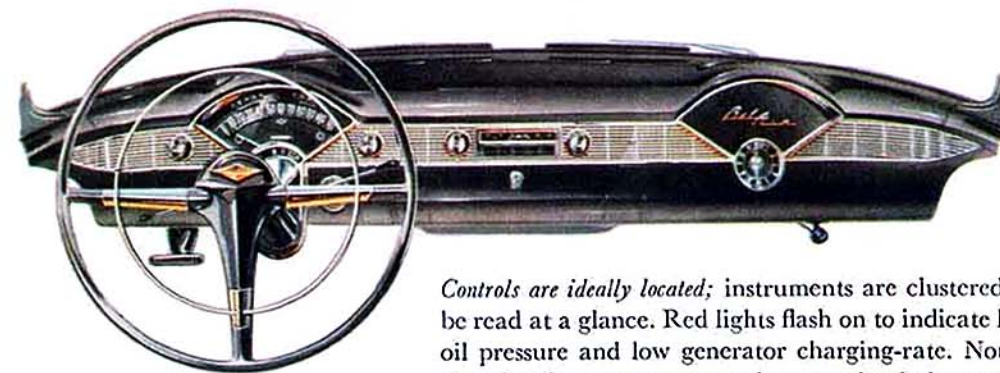

Controls are ideally located; instruments are clustered to be read at a glance. Red lights flash on to indicate low oil pressure and low generator charging-rate. Notice that the glove compartment is conveniently located in the center. The clean, balanced design of the instrument panel (Bel Air series illustrated) is in keeping with the classic lines of Chevrolet's overall styling.

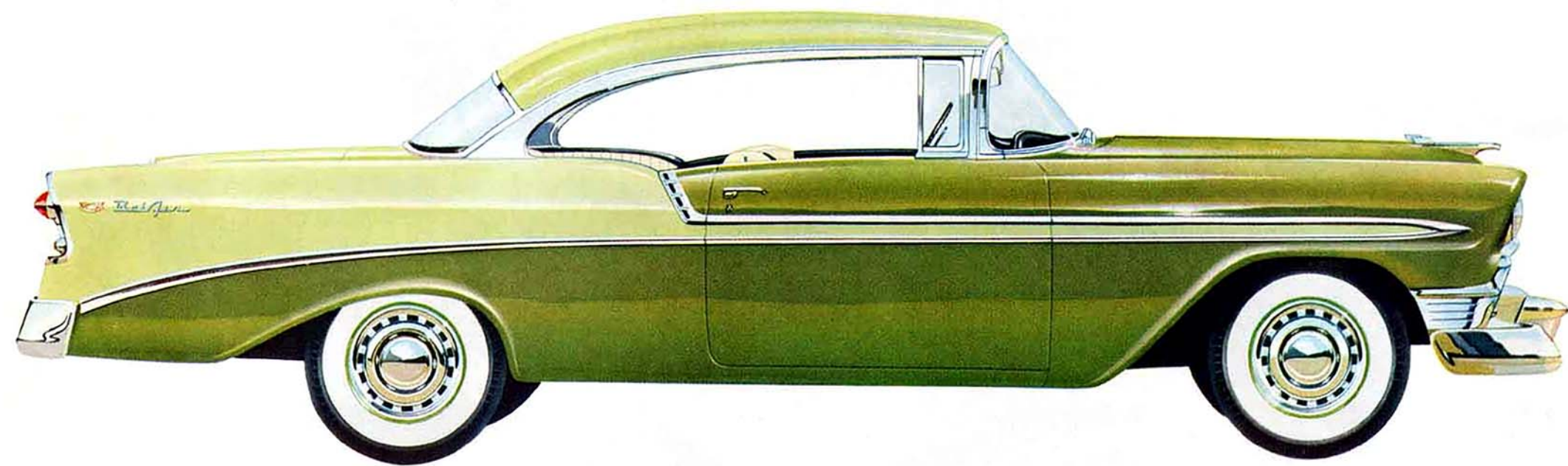

THE BEL AIR SPORT COUPE

Chevrolet proudly presents *two* new sport coupes and a bright new version of the Delray Club Coupe for 1956. All rate a special kind of pride for they're show stealers from the word go. And *how* they go. Beautifully behaved, powered by V8 or 6—smooth and ripple-free, lancing down the highway—a breeze to handle in tight city traffic! You'll especially like the fine-car atmosphere of their handsomely tailored interiors.



THE "TWO-TEN" SPORT COUPE



THE "TWO-TEN" DELRAY CLUB COUPE

With its club coupe styling, the Delray features sedan roominess and a washable, all-vinyl interior (even side walls and roof linings) that's *made* for family wear. The contemporary interior (below) is standard; custom-colored interiors, keyed to many exterior colors, are available at slight extra cost.

BEL AIR SPORT COUPE INTERIOR



Illustrated in *Custom-Colored* charcoal gray pattern cloth with yellow leather-grain vinyl trim.

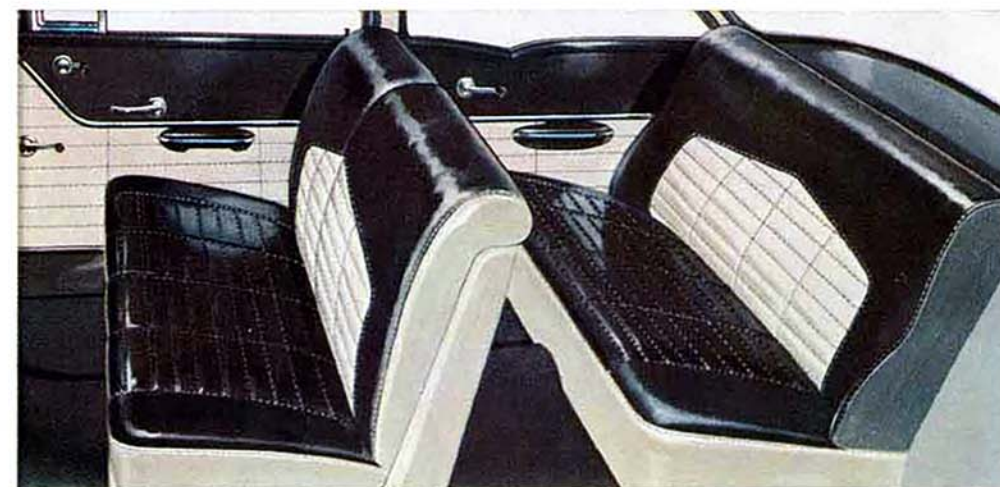

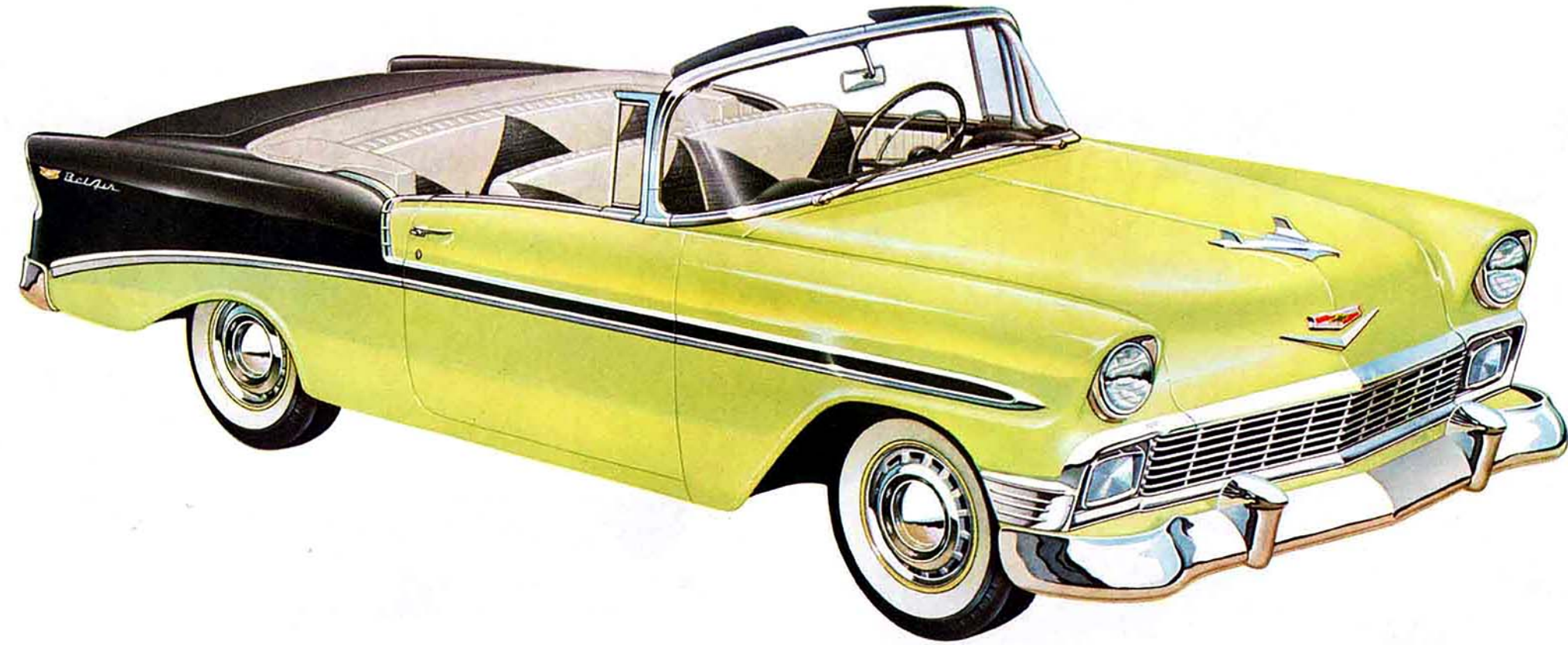

THE BEL AIR CONVERTIBLE

For the real convertible fan (top down and the sky's the limit!) here's the Bel Air made to order. You'll notice that Chevrolet's low-swept speed-line styling for '56 lends itself especially well to sport model design. And wait till you see the color choice of dazzling solids and two-tones! All-vinyl! Convertible interiors are the last word in high-fashion styling.



Weather-resistant top fabrics are finished in Ivory, Blue, Tan and Black to complement the exterior body color.



THE "ONE-FIFTY" UTILITY SEDAN

Neat and trim . . . with gleaming natural beauty that speaks well of you and your business! There's ample space in trunk and rear compartment for luggage and sample cases. Brilliant performance—in V8 or 6—is as much a part of this model as any new Chevrolet; yet it's lowest priced of all!

BEL AIR CONVERTIBLE INTERIOR



Illustrated in *Custom-Colored* charcoal gray pattern vinyl with yellow leather-grain vinyl trim.



Black pattern cloth with gold leather-grain vinyl trim.

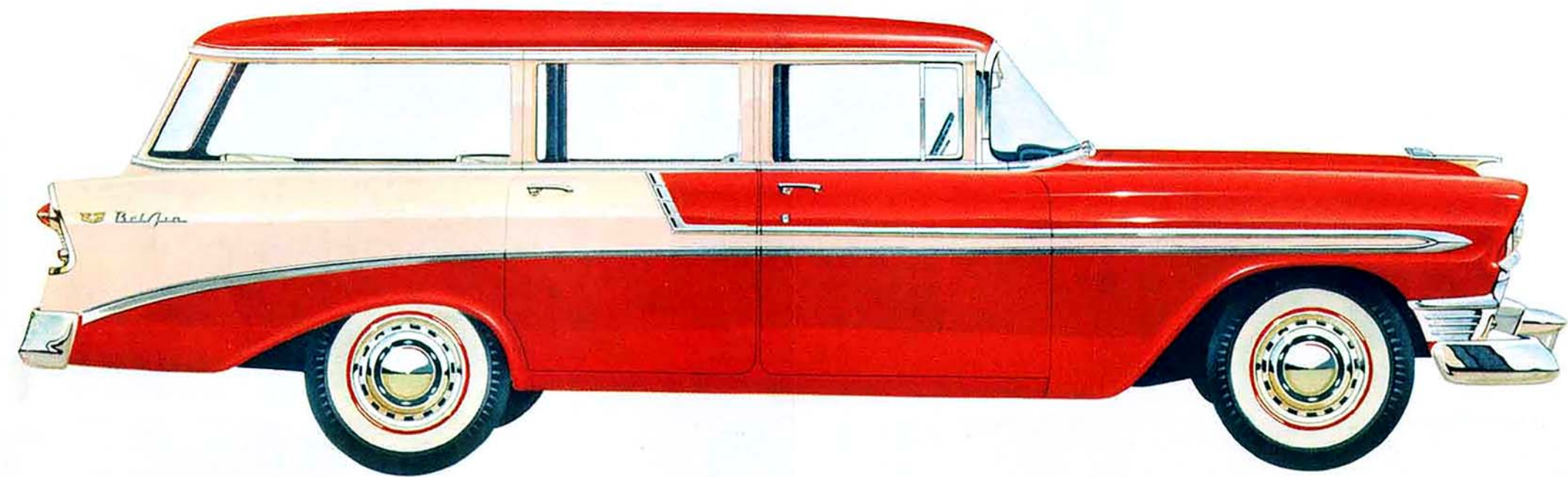

THE BEL AIR BEAUVILLE
4-DOOR 9-PASSENGER STATION WAGON

Your choice of SIX high-capacity Chevrolet station wagons for 1956! Two 9-passenger and four 6-passenger models — all brilliantly styled to stand out in any company, anywhere. Interiors are *functionally* handsome. Bel Air interiors are a rich combination of fine, charcoal pattern cloth and sturdy, ivory vinyl. In the "Two-Tens" and "One-Fifties," seats, sidewalls, and roof lining are styled in tough, washable vinyls. Load surfaces are covered with long-wearing ribbed linoleum.



THE "TWO-TEN" BEAUVILLE
4-DOOR 9-PASSENGER STATION WAGON



THE "TWO-TEN" TOWNSMAN
4-DOOR 6-PASSENGER STATION WAGON

BEL AIR STATION WAGON INTERIOR—



A separate folding section of the center seat in 9-passenger Station Wagons enables three adults to occupy this seat (as illustrated above); folds down to permit easy entrance and exit for rear seat passengers.

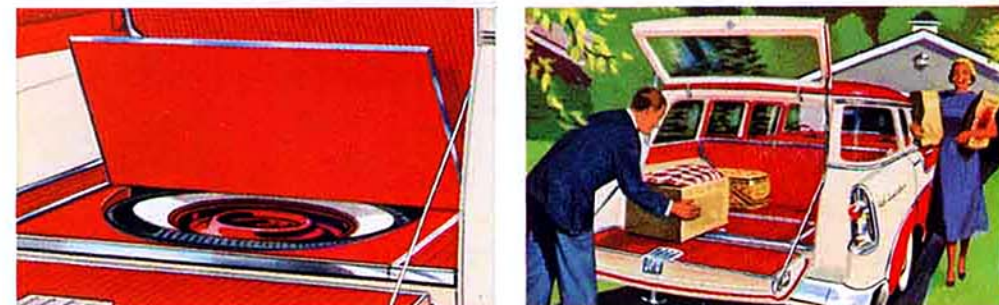

Rear seat in 6-passenger models folds flat quickly and easily for the sake of cargo—up to $\frac{1}{2}$ -ton of it! The spare tire is carried under the floor where it doesn't take up load space—it's always handy when you need it.

Perfect for play. Even with children aboard, long trips seem less of a chore. And driving is a pleasure! You'll especially like the smooth, road-hugging ride of a Chevrolet station wagon.

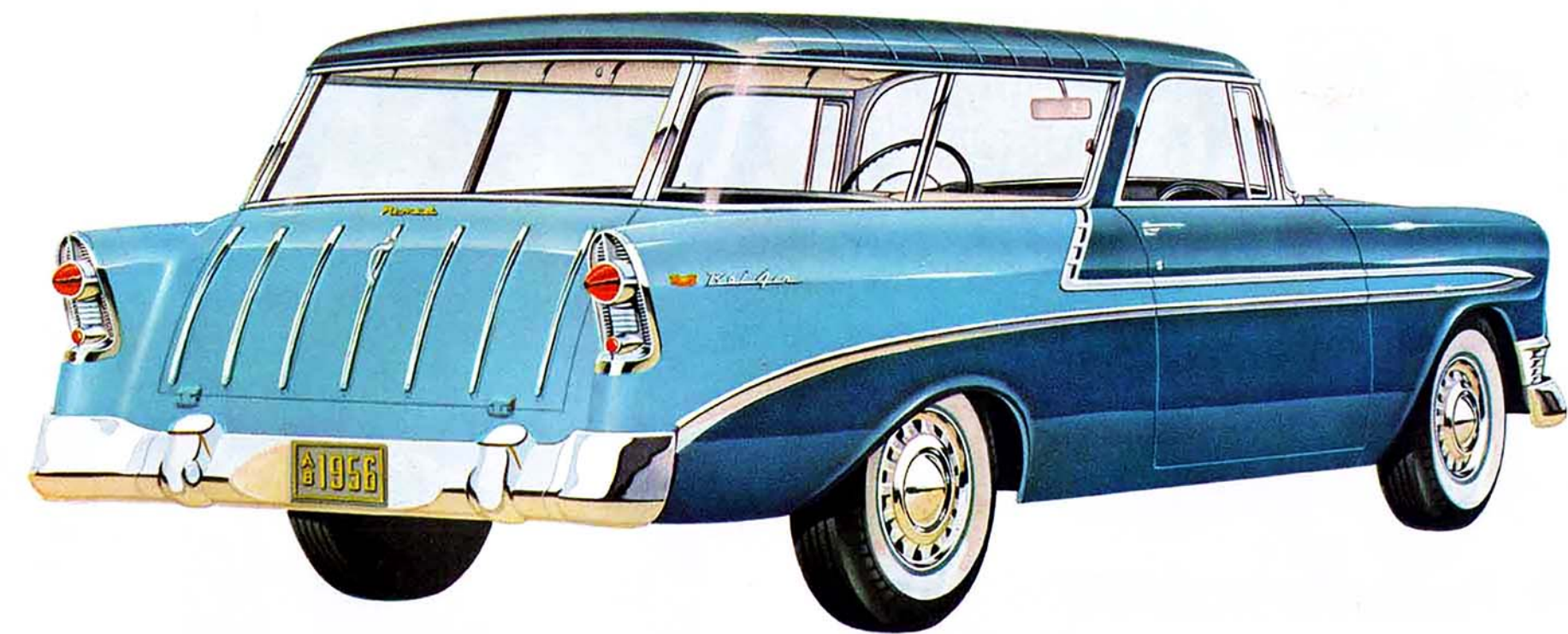

THE BEL AIR NOMAD

Three new 2-door station wagons to choose from—including the incomparable Bel Air Nomad! Though it assumes the fun-loving air of a sports car, the Nomad is as versatile as the next Chevrolet wagon. They all have a way of fitting the picture beautifully, whether breezing along to a golf date or running the kids to school. The standard Nomad two-tone interior (opposite) proves a good point: Chevrolet wagons are as good looking inside as they are outside.

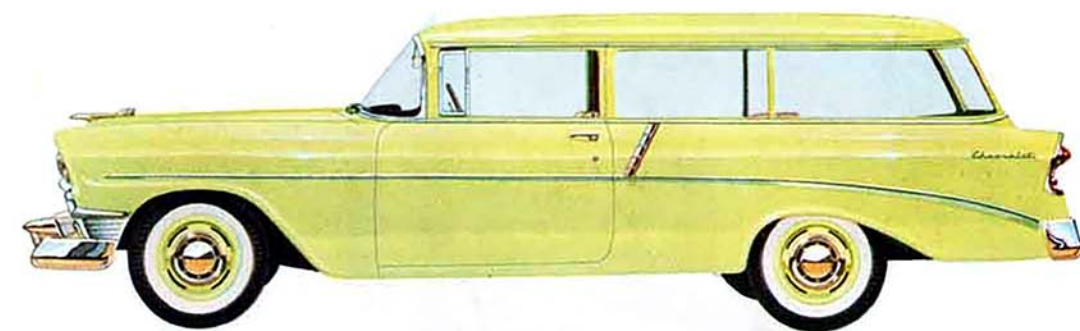

THE "TWO-TEN" HANDYMAN 2-DOOR 6-PASSENGER STATION WAGON

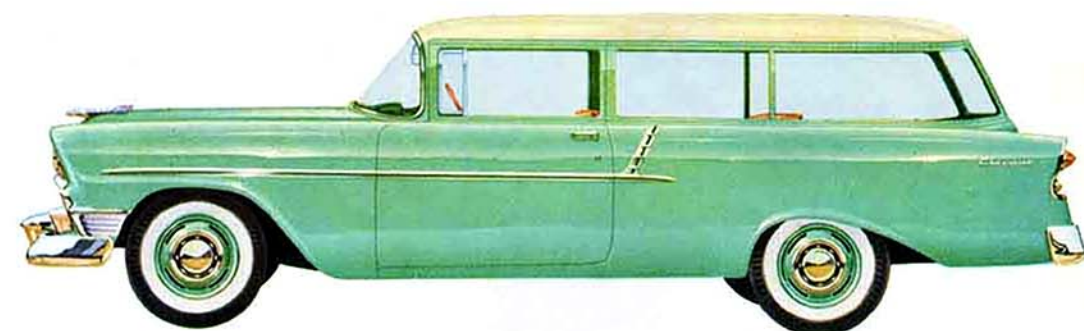

THE "ONE-FIFTY" HANDYMAN 2-DOOR 6-PASSENGER STATION WAGON

BEL AIR NOMAD INTERIOR

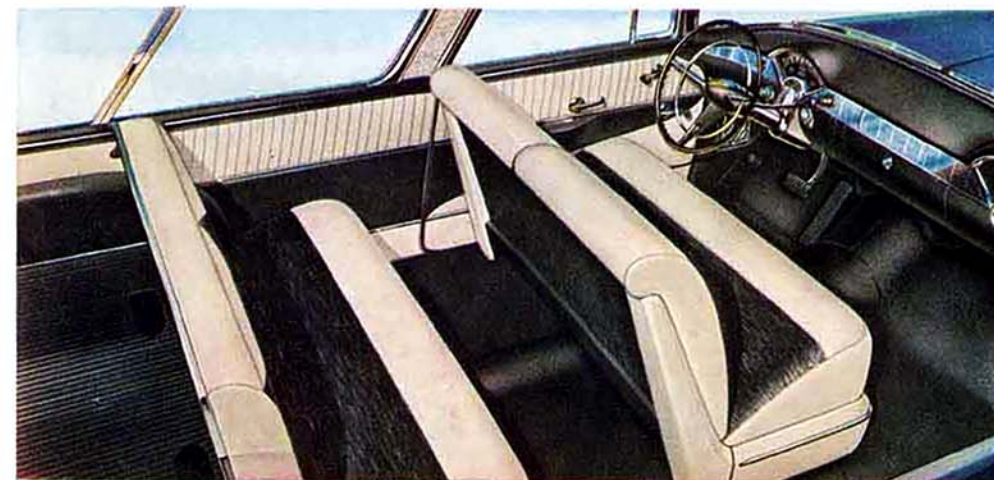

Charcoal gray pattern cloth with ivory leather-grain vinyl trim.



Both the seat cushion and backrest (of rear seat in 6-passenger models; middle seat in 9-passenger) fold flush with the load platform, providing a cargo floor of nearly 9 feet to the end of the tailgate.

Sure, the Nomad interior looks—and is—luxurious, and it's designed to *stay* that way under all kinds of everyday use! Those fine fabrics and sturdy vinyls are long-wearing, practical, easy to care for.

V8 OR 6 — MOST MODERN POWER IN CHEVROLET'S FIELD!

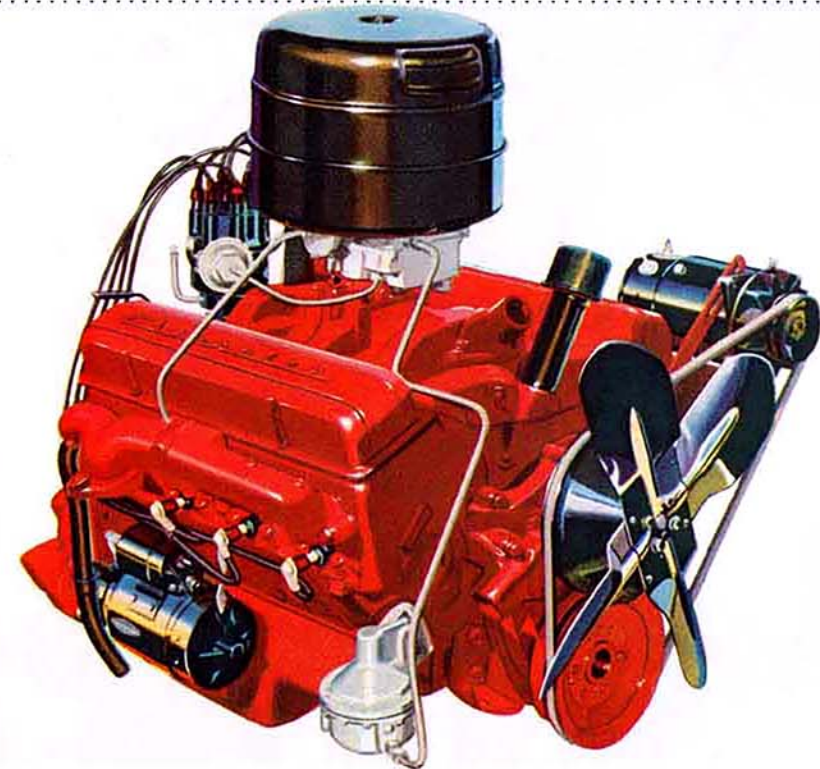
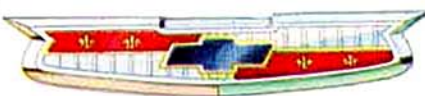

"TURBO-FIRE V8"—Light, rigid and compact, Chevrolet's record-smashing V8 puts less weight on the front wheels, permits better car balance! With its short-stroke design and exceptionally high horsepower per pound, it's the most modern V8 of all—built to perform brilliantly in city traffic or out on the highway. It squeezes more power out of a gallon of gas and requires only four quarts of oil in the crankcase! "Turbo-Fire V8" performance is a thrill you have to experience to really appreciate!

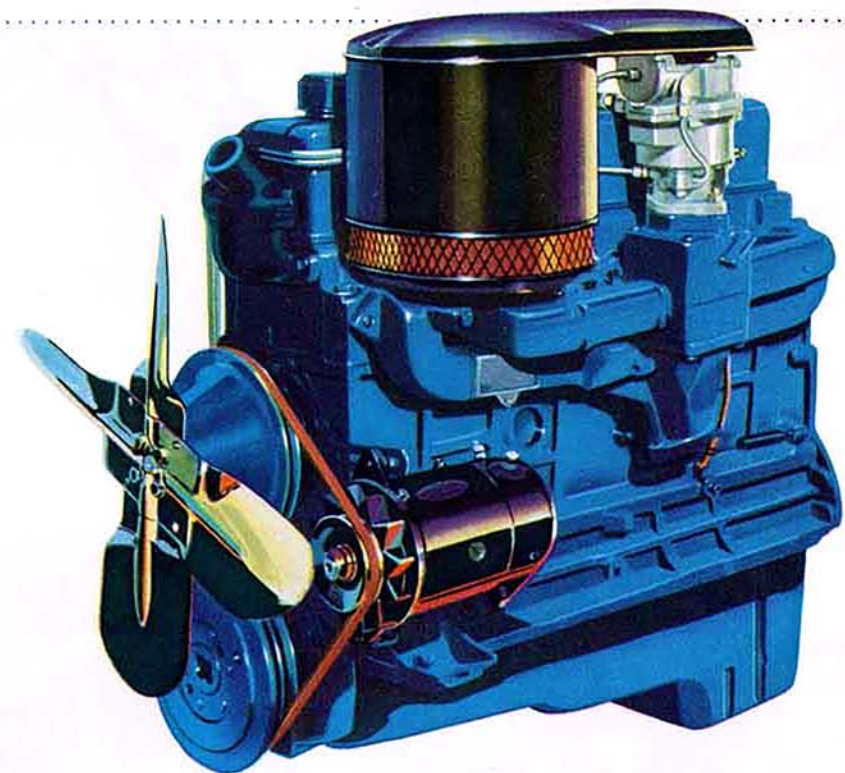

NEW "BLUE-FLAME 140"—It's the most powerful, most efficient 6 Chevrolet has ever produced for regular passenger cars. It offers traditional Chevrolet economy and dependability—but with a higher compression ratio (8 to 1!) and greater horsepower for livelier performance! Acceleration is faster, from a standing start up through all speed ranges. New features, now with all drive combinations, include hydraulic-hushed valve lifters, Hi-Lift camshaft, full-pressure lubrication and a hefty 12-volt electrical system.

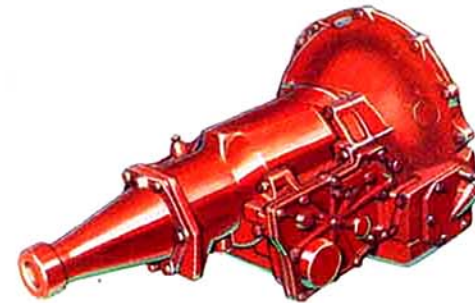

POWERGLIDE. Chevrolet's popular automatic drive—oil smooth, lightning-fast on the getaway and extra-easy on the gas mileage. You'll especially like Powerglide's pep—the quiet, quick way it accelerates or passes on the highway. Available with V8 or 6, optional on all models at extra cost.

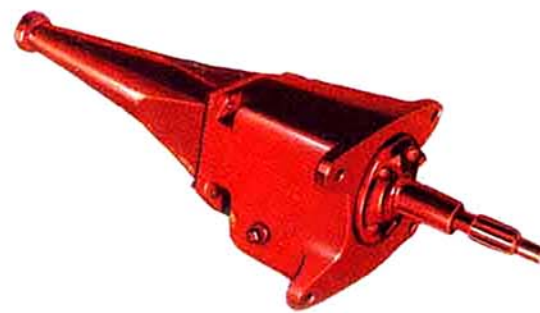

SYNCHRO-MESH. Chevrolet's standard transmission—a rugged, heavy-duty unit famous for its smooth operation, extra durability and outstanding gasoline economy! You shift quickly and smoothly through the range. Available with V8 or 6 as standard equipment on all models.



OVERDRIVE. You get great performance with Chevrolet Overdrive, plus *big gas savings!* This is the power helper that lets your engine loaf along while you really cover ground. Saves engine wear and tear! Teamed with V8 or 6, it is available on all models as an extra-cost option.



"SUPER TURBO-FIRE V8." It's a more powerful version of Chevrolet's famous "Turbo-Fire V8" . . . delivering high horsepower with 9.25 to 1 compression ratio! Models equipped with this high-performance engine can be identified by their distinctive dual-exhaust outlets. Optional at extra cost.

NAME YOUR POWER!

1. "BLUE-FLAME 140"—the last word in 6-cylinder power; with 140 h.p. and a high 8.0 to 1 compression ratio.
2. "TURBO-FIRE V8"—Chevrolet's famous 162 h.p. short-stroke V8 (170 h.p. with Powerglide models); with a compression ratio of 8.0 to 1.
3. "SUPER TURBO-FIRE V8"*—with brilliant 205 h.p. and 9.25 to 1 compression. A big reason why the hot one's even hotter!
4. "CORVETTE V8"*—the latest addition to a great line of Chevrolet engines. It's designed for sports car performance and even more powerful than the "Super Turbo-Fire!"

CHOOSE YOUR DRIVE!

- | | | |
|--|------------------------------|---------------------------|
| 1. HEAVY-DUTY SYNCHRO-MESH—standard in all models. | 2. SUPER-SMOOTH POWERGLIDE.* | 3. TOUCH-DOWN OVERDRIVE.* |
|--|------------------------------|---------------------------|

*Optional at extra cost.

IN YOUR NEW '56 CHEVROLET YOU CAN HAVE WHATEVER ENGINE-TRANSMISSION COMBINATION YOU WANT!

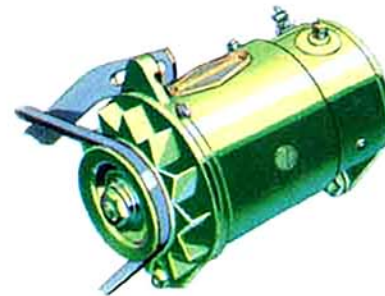

12-VOLT ELECTRICAL SYSTEM. Your engine snaps awake more quickly and easily, even on cold mornings, with Chevrolet's powerful 12-volt system! You can count on better ignition while driving (more power to the spark plugs) and a greater electrical reserve.

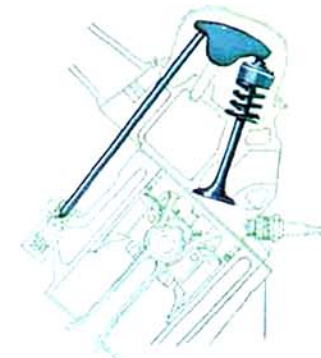

HYDRAULIC VALVE LIFTERS. Quieter, smoother Hydraulic valve lifters eliminate the need for periodic adjustment. Standard in "Blue-Flame", "Turbo-Fire V8" and "Super Turbo-Fire V8" engines. Full-pressure lubrication guards against engine wear, increases engine life.

THE REASON FOR CHEVROLET'S SMOOTH, ROAD-HUGGING RIDE . . .

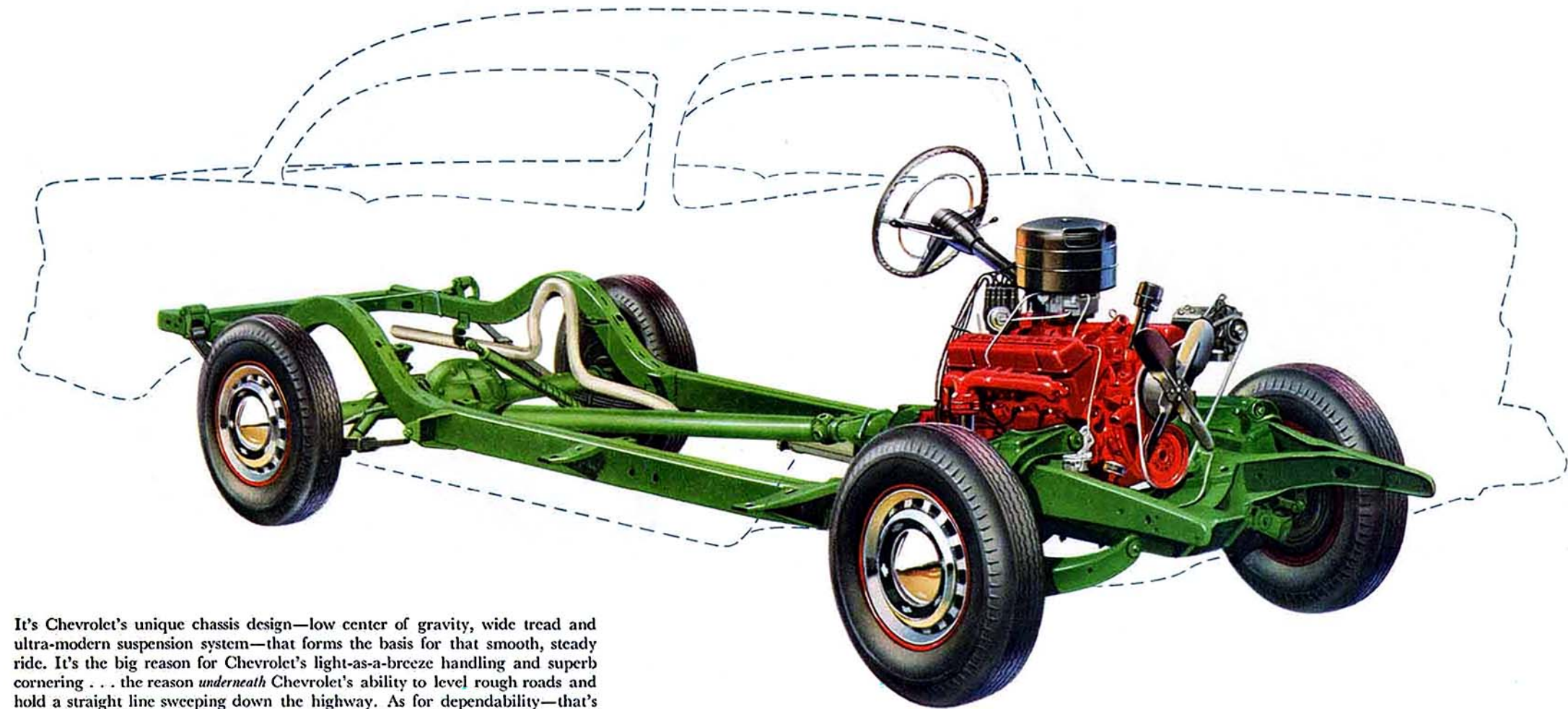

It's Chevrolet's unique chassis design—low center of gravity, wide tread and ultra-modern suspension system—that forms the basis for that smooth, steady ride. It's the big reason for Chevrolet's light-as-a-breeze handling and superb cornering . . . the reason *underneath* Chevrolet's ability to level rough roads and hold a straight line sweeping down the highway. As for dependability—that's traditional with Chevrolet. Rugged reliability, a bare minimum in the way of maintenance—these are advantages for which Chevrolet has always been famous!

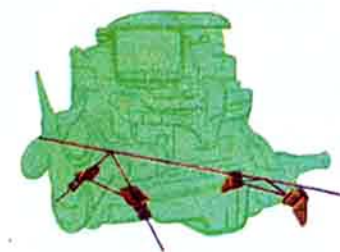

POISED-POWER ENGINE MOUNTS—Four large rubber cushions support the engine in a balanced position . . . smooth out vibrations and power impulses before they can be transmitted to the frame.

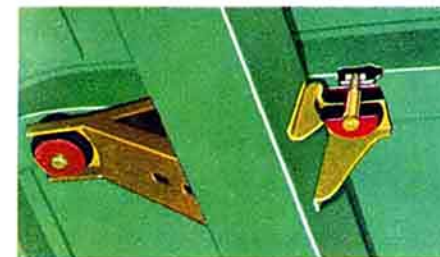

LIVE RUBBER BODY MOUNTS—At every point where closed bodies are secured to the frame, live rubber cushions all but eliminate vibrations and road shocks—making the ride quieter, more comfortable.



HEADS-UP STOPPING—Anti-Dive Braking, an exclusive Chevrolet development, all but eliminates nose-down stopping. And there's less chance of bumpers locking when you stop suddenly in tight traffic.

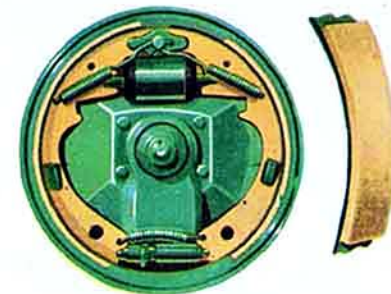

BIG, FAST-ACTING BRAKES—Chevrolet's Jumbo-Drum brakes hold the instant you touch the pedal. They're self-energizing—less foot pressure is needed! Linings are bonded (no rivets) for longer life.

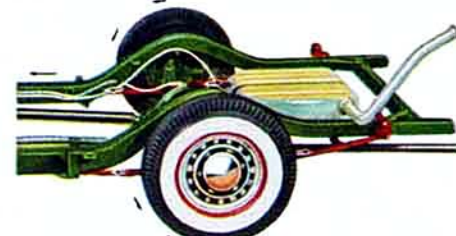

HOTCHKISS DRIVE—In this system, the rear axle and wheels are connected to the frame through the rear springs. As a result, drive line and road shocks are cushioned directly by the springs.



BALL-RACE STEERING—A Chevrolet exclusive in its field! Ball bearings in the steering system minimize friction—you take corners and curves with feather-touch control; tight-spot parking is far easier!

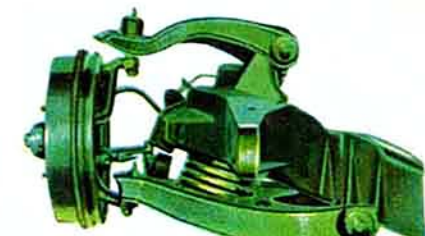

GLIDE-RIDE FRONT SUSPENSION—With spherical joints absorbing the bumps, you roll smoothly and steadily over the road with shock, vibration and noise all minimized. Driving is more enjoyable.



EXTRA-LOW-PRESSURE TUBELESS TIRES—At no extra cost! Greater resistance to blowouts and slower deflation if punctured—those are the big advantages of having tubeless tires. They're easier to repair, too!

THE EXCLUSIVE ADVANTAGES OF BODY BY FISHER

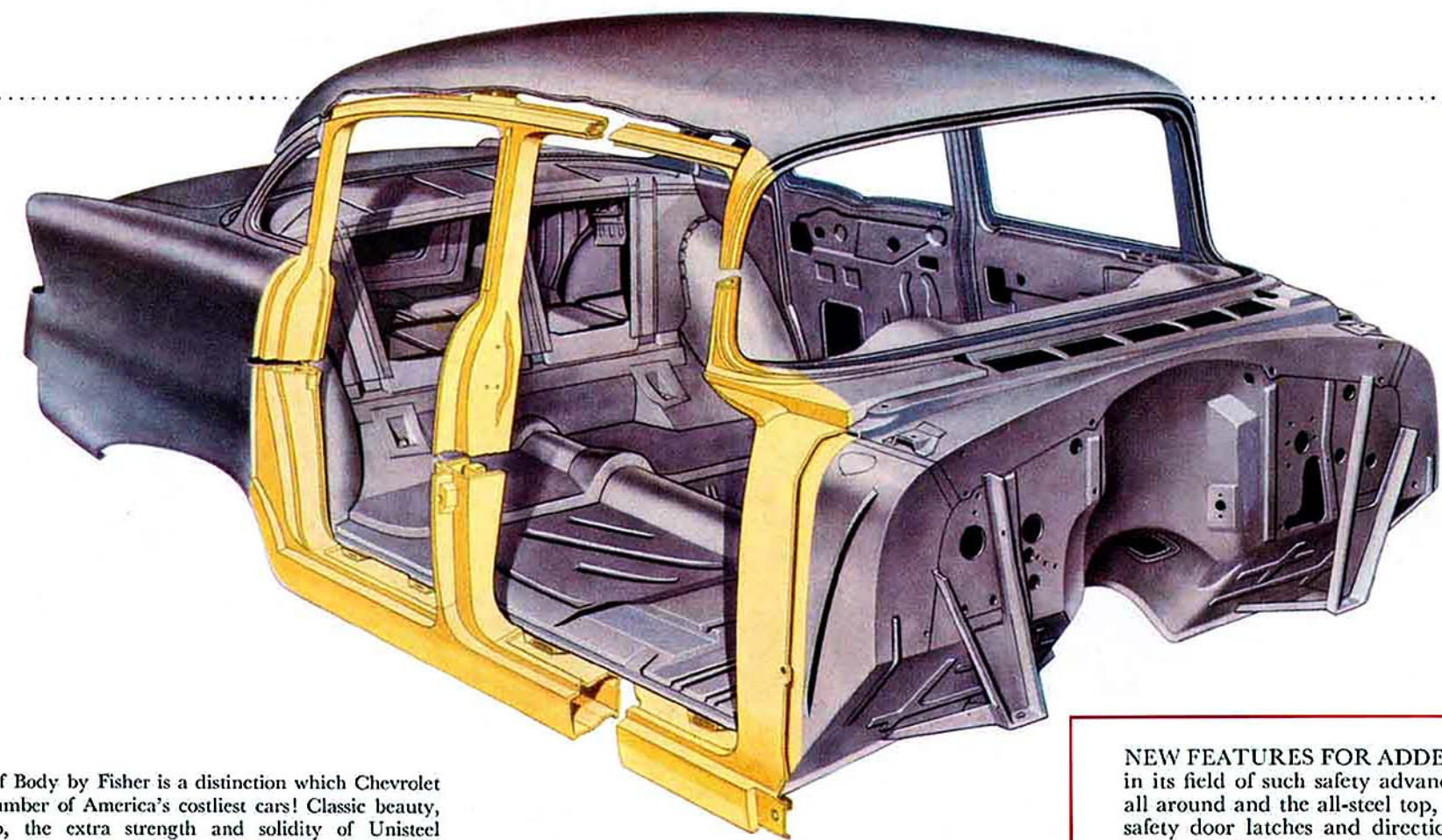

The traditional quality of Body by Fisher is a distinction which Chevrolet proudly shares with a number of America's costliest cars! Classic beauty, unexcelled craftsmanship, the extra strength and solidity of Unisteel construction . . . extra comfort, safety and dependability *built in*. These are advantages which only the world's largest producer of automobile bodies could offer—advantages only Chevrolet brings to the low-price field!

NEW FEATURES FOR ADDED SAFETY—A pioneer in its field of such safety advances as Safety *Plate* Glass all around and the all-steel top, Chevrolet now provides safety door latches and directional signals as standard equipment in all models. Seat belts, with or without shoulder harness, and instrument panel padding, are optional at extra cost.

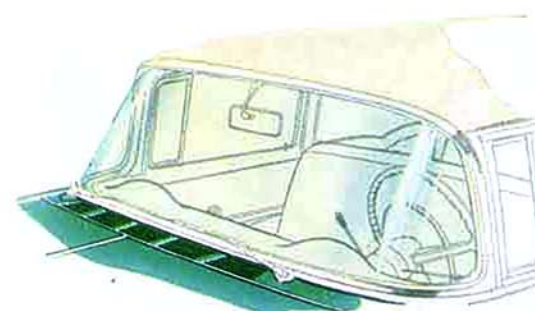

HIGH-LEVEL VENTILATION—Air is taken in above road heat, fumes and dust and passed through a special chamber which keeps rain out of the car. A more even flow of air means the best of ventilation.

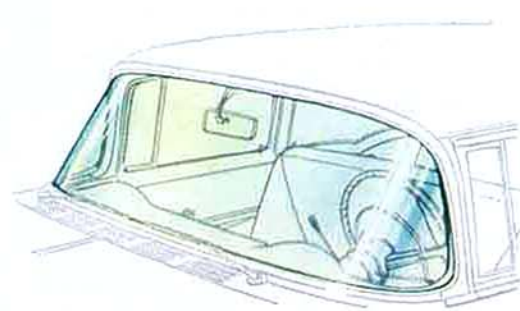

PICTURE-WINDOW VISIBILITY — A sweeping view ahead through the rakish panoramic windshield . . . a wonderful view all around! The driver can see all four fenders. Ventipanes are crank operated.



REAR DOOR SAFETY LOCKS—Standard equipment on all 4-door models. With lock button down, the door cannot be opened, *even from the inside*, until lock button is pulled up. Ideal to protect small children.

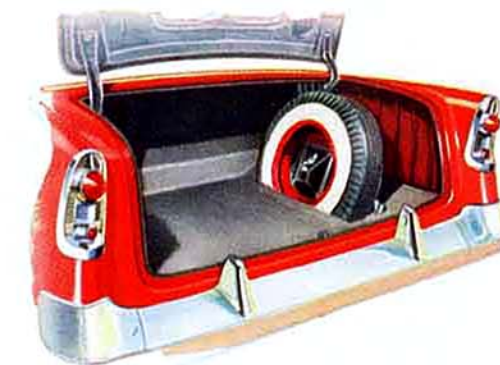

LUGGAGE COMPARTMENT—Room to spare in that wide, deep trunk compartment and the low sill makes loading and unloading easier. At night, lights in the bumper guards illuminate the compartment.

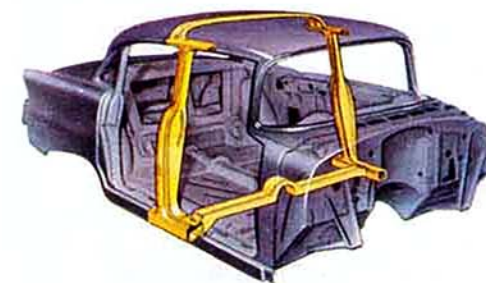

EXTRA-STRONG CENTER FRAMING —The center pillars, floor brace and center roof bow form a rigid frame structure around the middle section of the body. There's extra safety in this Fisher Body construction!

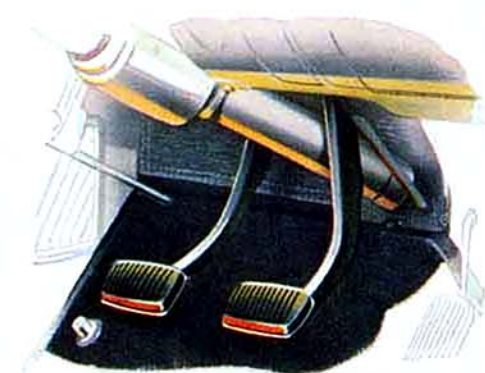

SWING-TYPE PEDALS—Both the brake and clutch pedal swing downward with a light touch of the toe. With the pivotal point *above*, the floor is left free and clear, giving you more comfortable foot room.



CONCEALED GASOLINE FILLER — Swing open the hinged left rear tail lamp and you find the gasoline filler cap—another feature Chevrolet shares exclusively with some of America's costliest cars!

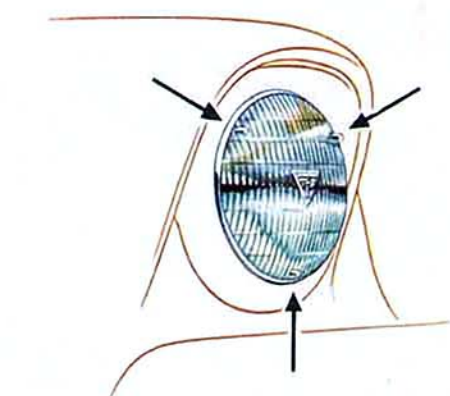

NEW SEALED BEAM HEADLAMPS—Make night driving safer and more pleasant. Special aiming lugs—exclusive with General Motors cars—insure full benefits of the new beam pattern.

**AUTOMATICALLY...
CHEVROLET MAKES DRIVING MORE ENJOYABLE!**

**CHEVROLET POWER FEATURES
AVAILABLE AT EXTRA COST**

POWER STEERING. There's nothing to parking, making tight turns or maneuvering through traffic, with Power Steering on the job. It contributes to safety, too—makes it easier to keep your car under control in spite of ruts, bumps or even a blowout.

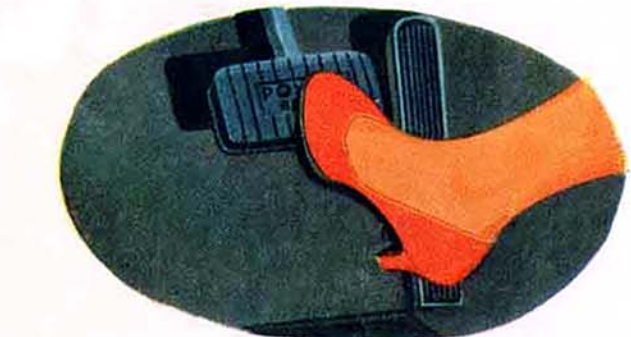

POWER BRAKES. Nothing new to learn—even easier on the driver—and he doesn't have to worry about stopping too suddenly. A light touch of the pedal and the car comes to a halt quickly but smoothly, with Power Brakes doing up to one-third of the work. The low set pedal permits an easy swing of your foot from accelerator to brake.



POWER-POSITIONED FRONT SEAT AND AUTOMATIC WINDOW CONTROLS. With push-button ease, the front seat adjusts to your most comfortable position—front and rear windows are raised or lowered. Master control switch on left front door—individual controls on each window. Available on all Bel Air and "Two-Ten" models.



CHEVROLET ALL-WEATHER AIR CONDITIONING BY FRIGIDAIRE. A comfortable car climate all year round (quieter and cleaner, too) and you save the cost of a heater! Both the heater core and cooling coils are contained on one compact unit *under the hood*. Available at extra cost in all V8 models except the convertible.

ENGINEERING SPECIFICATIONS



CAR EXTERIOR DIMENSIONS

Sedans and Coupes: Overall length, 197.5". Overall width, 74.0". Loaded height, 60.5" (Sport Coupe, Sport Sedan, and Convertible, 59.1"). **Station Wagons:** Overall length, 200.8". Overall width, 74.0". Loaded height, 60.8".

POWER PLANT

Engine: 6-cylinder or 8-cylinder, high-compression, valve-in-head engine with h.p. ranging up to 225. Specifications listed below and in center chart. **Pistons:** Tin-coated aluminum alloy, with expansion-controlling steel struts, offset pins, three rings. **Crankshaft:** Precision-counterbalanced, forged steel. Harmonic balancer. Alloy iron camshaft. **Bearings:** Precision replaceable steel-backed babbit (crankshaft, and connecting rods). **Lubrication:** Controlled full-pressure system. Fixed oil intake. Oil Filter*. Refill, 5 qt. (V8, 4 qt.). **Fuel System:** Downdraft carburetion. Automatic choke. Air cleaner. Thermostatic fuel mixture heat control. High-turbulence combustion chambers. 16-gallon tank (17, station wagons) with filter screen in tank. Fuel filler concealed by left tail light.

Exhaust System: 30" reverse-flow muffler with three resonance chambers. Special 24" muffler for Convertible. Super Turbo-Fire V8 and Corvette V8 have full dual exhaust system.

Cooling System: Ribbed cellular radiator with pressure cap. 4-blade fan and life-lubricated water pump. Thermostat and by-pass temperature control. Full-length water jackets around all cylinders. Capacity, 16 qt. (17 qt. with heater).

Electrical System: 12-volt system. 54-plate battery (53 ampere-hour rating at 20 hours). 25-ampere generator, with current and voltage regulators. Solenoid-actuated positive-shift starter. All-weather ignition. Automatic centrifugal and vacuum spark control.

Mounting: Balanced on rubber cushions.

SUSPENSION SYSTEM

Frame and Bumpers: Double-drop box-girder frame (special X-structure of I-beams in Convertible). Contoured wraparound bumpers, with guards.

Front Suspension: Independent coil spring sus-

pension, with coaxial life-sealed double-acting shock absorbers. Self-adjusting spherical-joint steering knuckles with non-metallic bearings. Four lubrication fittings.

Rear Suspension: Semi-elliptic leaf springs, 58" by 2". Lubrication-eliminating leaf inserts. Outrigger mounting, with compression shackles. Diagonally mounted life-sealed double-acting shock absorbers.

Wheels and Tires: Steel disk wheels; 5" rims. Full wheel disks on Bel Air models; hub caps on others. 6.70-15-4 p.r. extra-low-pressure tubeless tires. 6.70-15-6 p.r. on nine passenger station wagons. Wheelbase, 115". Front tread, 58". Rear tread, 58.8".

CONTROLS

Brakes: Hydraulic, self-energizing, with bonded linings. 11" dia. drums with cast alloy iron braking surfaces. Braking dive controlled by suspension. Mechanical actuation of rear brakes for parking. **Steering:** Recirculating ball-nut steering gear; ratio 20 to 1. Relay type linkage. Overall ratio, 25.7 to 1.

Driving Controls: 18" steering wheel (3-spoke on Bel Air models; 2-spoke on others). Full-circle horn ring on Bel Air and "Two-Ten" models; horn button on "One-Fifty" models. Transmission and direction signal control levers, with mechanism inside steering column. Parking brake T-handle at left of steering column. Suspended brake and clutch pedals. Treadle accelerator. Foot-controlled headlight beam switch. Light switch. Key-turn starter and ignition lock switch. Windshield wiper and ventilation controls.

Instruments: Speedometer. Fuel gauge. Heat indicator. Generator charge, oil pressure, and country beam warning lights. Direction signal arrows. Adjustable indirect instrument lighting. Lighted automatic transmission selector indicator on instrument panel.

Vision Aids: Two windshield wipers. Full-width defrosting. Inside mirror. Two sun shades (one, "One-Fifty" models).

Driving Lights: Precision-aimed sealed beam headlights, protected by dual circuit breakers. Parking lights. Tail and stop light units, with red reflex buttons. Dual rear license lights.

BODY CONSTRUCTION

Structure: Welded steel. Turret top with central bow (except Convertible). Station wagons (except Nomad) have two roof bows. Full-length floor. Double-walled cowl. Unitized sides and rear fenders. Lacquer finish.

Closures: Rear-opening double-walled doors. Concealed hinges; swing-out type front door hinges. Door checks. Safety type rotary locks. Pushbutton

outside handles; lever inside controls. Button-on-still locks, with rear door safety adjustment. Aluminum sill plates. Two-panel sedan and coupe deck lid: Concealed torque-rod counterbalancing hinges, key release, lift handle, slam latch. Extra-low trunk sill. Box-section station wagon lift gate: Concealed hinges, self-latching supports, wedge lock. Double-walled station wagon tail gate: Exposed hinges, support cables with re-wind springs, slam latches operated by outside T-handle. Key locks for both front doors, deck lid or end gates. Front-opening hood: Counterbalancing hinges, slam latch with safety catch. Convertible folding fabric top: Zippered-in rear curtain with vinyl plastic window, vinyl boot, hydraulic operating mechanism.

Insulation: Thorough sealing and insulation.

Front Ventilation: High-level air intake in top of cowl; individually controlled outlets in cowl sides.

Mounting: Rubber cushioned (except Convertible). Stabilized front-end mounting.

BODY EQUIPMENT

Windows: High quality safety glass in windshield and all windows. Windshield: One-piece panoramic; vertical pillars. Door windows: Crank-down. Crank-operated front door ventipanes. Rear quarter windows: Crank-down (2-door sedans, coupes). Stationary (4-door sedans, Utility Sedan). Wrap-around stationary (station wagons) with movable front sections (Bel Air and "Two-Ten" 2-door models). Rear window: Wraparound (sedans, coupes except Convertible). Curved (station wagons).

Seats: Full-width; steel frames with S-wire springs. Front seat Solid back (4-door models); split center-fold back (2-door models). Foam rubber cushion (Bel Air and "Two-Ten" models). Inclined-plane seat adjustment. Rear seat: Foam rubber cushion (Bel Air sedans, coupes and Nomad). Folding seat (six-passenger station wagons). Nine-passenger station wagon: Folding center seat with off-center divided back, removable rear seat.

Upholstery and Trim: All vinyl (Convertible, Club Coupe, "Two-Ten" and "One-Fifty" station wagons); combinations of pattern cloth and vinyl (others). Chrome front seat and side wall moldings (Bel Air and "Two-Ten" models); windshield top and side molding (Convertible). Vinyl headlining (Bel Air Sport Coupe, Sport Sedan, Nomad).

Floor Coverings: Carpet (Bel Air sedans, coupes, Nomad; "Two-Ten" Club Coupe). Rubber mats (others), also sedan and coupe trunk, Utility Sedan load space. Linoleum on platform, tail gate, and surface of folded rear seat (station wagons).

Appointments: Wraparound instrument panel with instrument cluster in front of driver, matching

radio grille, ashtray and central glove compartment with key lock. Automatic glove compartment light, ashtray on instrument panel on all jobs, and cigarette lighter (Bel Air and "Two-Ten" models) and electric clock (Bel Air models). Four arm rests (Bel Air and "Two-Ten" models, except two in station wagons). Two rear seat ash receptacles (Bel Air and "Two-Ten" 2-door models; one, Bel Air and "Two-Ten" 4-door sedans). Two assist straps (Bel Air and "Two-Ten" 2-door sedans, Club Coupe). Package shelf (sedans, coupes except Convertible).

Lights: Central dome light. Two courtesy lights under instrument panel (Convertible), two lights in Nomad. Manual switch on instrument panel. Automatic switches at all doors (Bel Air models); at front doors ("Two-Ten" models).

Exterior Chrome: Hood ornament, hood and rear emblems, light bezels, grille, bumpers, ventipane frames, handles, hub caps or wheel disks. "V" on

hood and rear deck (V8 models). V's on Nomad rear fenders. Windshield, rear window, side, and sash moldings ("Two-Ten" and "One-Fifty" models), window sill ("Two-Ten" models). Windshield and side window moldings; rear window reveal (except Convertible); windshield pillar moldings; sash and double side moldings (Bel Air models). Special top and belt moldings (Bel Air and "Two-Ten" station wagons).

FACTORY-INSTALLED OPTIONAL EQUIPMENT*

Overdrive. Automatic transmission. Heavy-duty oil bath air cleaner (all 6-cylinder models). Heavy-duty clutch. Low-pedal vacuum-power brakes. Hydraulic power steering. Electric windshield wipers. Tinted safety glass. Electric-power window lifts. Electric-power front seat adjustment. Heater and defroster. Air conditioner. Whitewall tires. Six ply tires. Heavy-duty rear springs.

POWER TEAMS	CONVENTIONAL	OVERDRIVE	AUTOMATIC
Blue-Flame 140	Valve-in-head 140-h.p. Six-cylinder engine. 235.5 cubic inch displacement. 3.56" bore, 3.94" stroke, 8.0 to 1 compression ratio. Concentric carburetor, 4-bearing crankshaft, gear-drive timing, hydraulic valve lifters.		
Turbo-Fire V8	Valve-in-head 162-h.p. (170-h.p. with Powerglide) V8 engine. 265 cubic inch displacement. 3.75" bore, 3.0" stroke, 8.0 to 1 compression ratio. Two-barrel carburetor, 5-bearing crankshaft, chain-drive timing, hydraulic valve lifters. Heavy-duty oil-bath air cleaner.		
Super Turbo-Fire V8	Valve-in-head 205-h.p. V8 engine. 265 cubic inch displacement. 3.75" bore, 3.0" stroke, 9.25 to 1 compression ratio. Four-barrel carburetor, 5-bearing crankshaft, chain-drive timing, hydraulic valve lifters, heavy-duty oil-bath air cleaner, dual exhaust system.		
Corvette V8	Valve-in-head V8 engine. 225 h.p. at 5200 rpm; torque, 270 ft.-lbs. at 3600 rpm. 265 cubic inch displacement. 3.75" bore, 3.0" stroke, 9.25 to 1 compression ratio. Dual four-barrel carburetors, two oil-bath air cleaners, special high-lift camshaft, high-speed mechanical valve lifters, high-power exhaust headers, dual exhaust system.		
Clutch	Diaphragm spring type with permanently lubricated throw-out bearing. 9 1/2" diameter on Six; 10" diameter on Turbo-Fire V8. Coil spring type, 10" diameter on Super Turbo-Fire V8 and Corvette V8.		None
Transmission	Heavy-Duty Transmission 3-speed, synchro-mesh selective gear transmission, with gearshift lever on steering column.	Heavy-Duty Transmission plus Overdrive* 3-pinion, planetary gear overdrive, providing automatic fourth speed; gear ratio, 0.71 to 1. Accelerator control: Electric cut-in, through releasing treadle, above 30 mph.; down-shift to direct drive by pressing treadle to floor. Pull-out knob locks out overdrive.	Automatic Transmission* Hydraulic, 3-element torque converter, with planetary gears for reverse and low. Selector lever on steering column. Safety switch in starter circuit. Oil cooler integrated with engine cooling system. Maximum torque converter ratio, 2.1 to 1. Planetary gear ratio, 1.82 to 1. Maximum overall ratio, 3.82 to 1.
Rear Axle	Semi-floating, with hypoid gears. Single-unit "banjo" housing. Hotchkiss drive.		
	3.70 to 1 ratio	4.11 to 1 ratio	3.55 to 1 ratio

All illustrations and specifications contained in this literature are based on the latest product information available at the time of publication approval. The right is reserved to make changes at any time without notice in prices, colors, materials, equipment, specifications and models, and also to discontinue models.

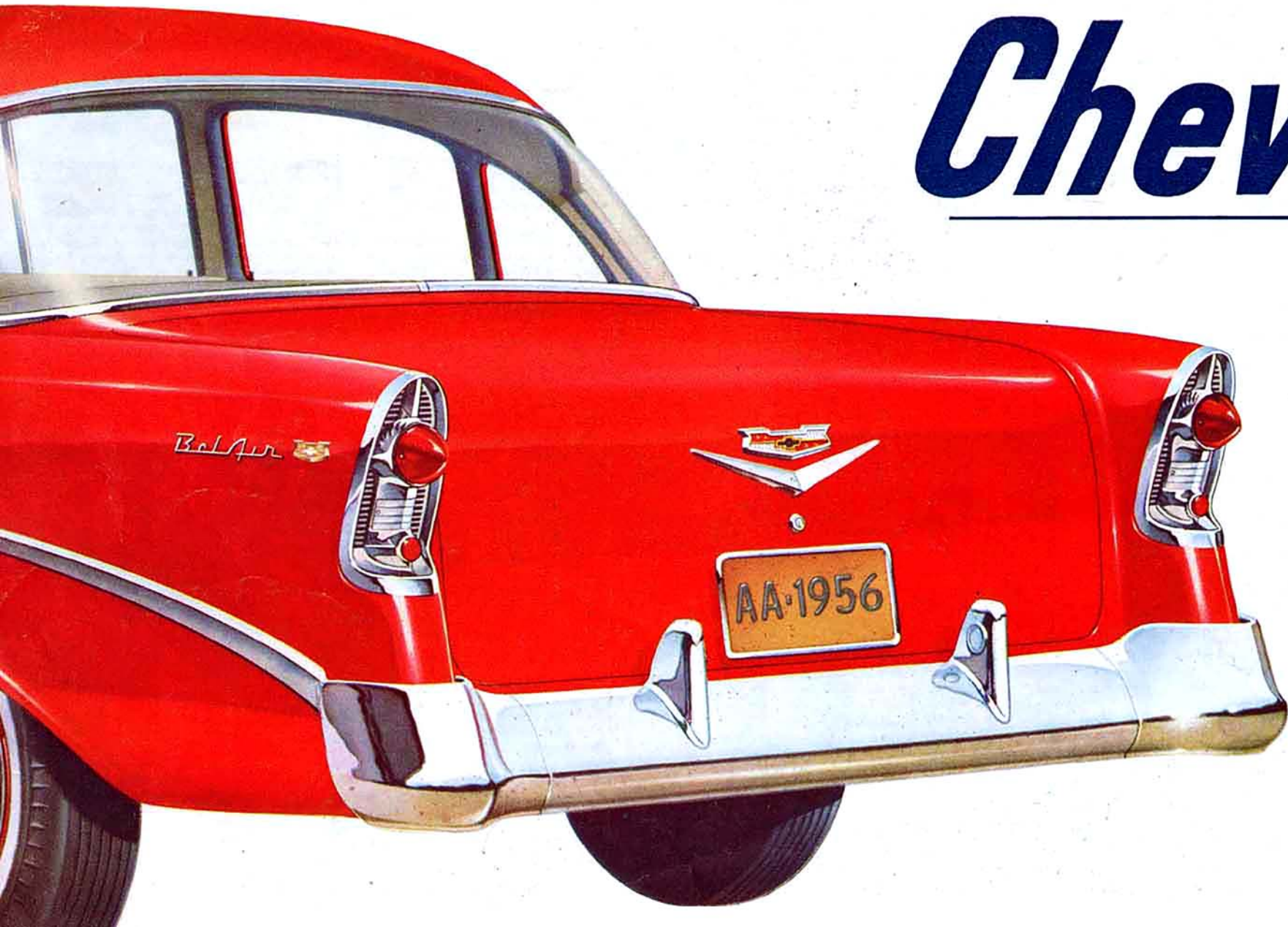

Chevrolet

*offering a
bigger, brighter
choice than ever!*